

Declaration of Conformity

We, Manufacturer

ZIPPY TECHNOLOGY CORP.
10F, No. 50, MIN CHYUAN RD.
SHIN-TIEN, TAIPEI HSIEN
TAIWAN, R.O.C.

declare that the product
(description of the apparatus, system, installation to which it refers)

SWITCHING POWER SUPPLY R3G-6650P

is in conformity with
(reference to the specification under which conformity is declared)
in accordance with 89/336 EEC-EMC Directive

- EN 55022 : 1998
Information technology equipment
-Radio disturbance characteristics
-Limits and methods of measurement
- EN 55024 : 1998
Information technology equipment
-Immunity characteristics
-Limits and methods of measurement
- EN 61000-4-2 Electrostatic discharge requirements "ESD"
- EN 61000-4-3 Radiated, radio frequency electromagnetic field
- EN 61000-4-4 Electrical fast transient requirements "EFT"
- EN 61000-4-5 Surge Immunity requirements
- EN 61000-3-2 /1995+ Harmonic current A12/1996+A13/1997+ requirements A1/1998+A2/1998
- EN 61000-3-3 /1995 Voltage fluctuations and flicker requirements
- EN 61000-4-6 Conducted Immunity
- EN 61000-4-11 Voltage Dip, interruptions Immunity requirements
- CE marking
- Low Voltage Directive (73/23/ECC,93/68/EEC) :
EN60950: 1992+A1+A2+A3+A4+A11 TUV certificate No: R50012701

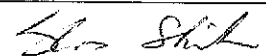
Manufacturer	
Date :	MAY,23,2002
Signature:	
Name:	ZIPPY

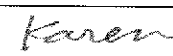
Test-Lab	
Date :	MAY,23,2002
Signature:	
Name:	ZIPPY

APPLICATION FOR CERTIFICATION

ON Behalf Of

ZIPPY TECHNOLOGY CORP.

SWITCHING POWER SUPPLY

Model#: R3G-6650P

FCCID:N/A

PREPARED FOR:

ZIPPY TECHNOLOGY CORP.

10F, No.50, MIN CHYUAN RD.

SHIN-TIEN, TAIPEI HSIEN

TAIWAN, R.O.C

Report By: ZIPPY TECHNOLOGY CORP.

10F, No.50, MIN CHYUAN RD.

SHIN-TIEN, TAIPEI HSIEN

TAIWAN, R.O.C

TEL:(02)2918-8512

FAX:(02)2913-4969

TABLE OF CONTENTS

Description	Page
1. Test Report Certification	5
2. General Information	6
2.1 Production Description	7
2.2 Tested System Details	7
2.3 Test Methodology	7
2.4 Test Facility	7
3. Electronic-Magnetic Interference Test	8
3.1. Conducted Power Line Test	8
3.1.1 Test Equipments	8
3.1.2 Block Diagram of Test Setup	8
3.1.3 Conducted Powerline Emission Limit	9
3.1.4 EUT Configuration on Measurement	9
3.1.5 EUT Exercise Software	9
3.1.6 Conducted Emission Data	10
3.2. Radiation Emission Test	11
3.2.1 Test Equipment	11
3.2.2 Test Setup	12
3.2.3 Radiated Emission Limited	12
3.2.4 EUT Configuration	13
3.2.5 Operating Condition of EUT	13
3.2.6 Radiated Emission Data	14
4. ESD Measurement	16
4.1 Test Equipments	16
4.2 Block Diagram of Test Setup	16
4.3 Severity Levels	17
4.4 EUT Operating Condition	17
4.5 Test Procedure	17
4.6 Test Method	17
4.7 Test Result	18

	Page
5. Radiated Susceptibility Measurement	19
5.1 Test Equipment	19
5.2 Block Diagram of Test Setup	19
5.3 Severity Levels	20
5.4 EUT Operating Condition.....	20
5.5 Test procedure.....	20
5.6 Test Method	20
5.7 Test Result	21
6. Electrical Fast Transient/Burst Measurement.....	22
6.1 Test Equipment	22
6.2 Block Diagram of Test Setup	22
6.3 Severity Levels	22
6.4 EUT Operating Condition.....	23
6.5 Test procedure.....	23
6.6 Test Method	23
6.7 Test Result	23
7. Harmonic Current Requirements	24
8. Voltage Fluctuation and Filcker Test	27
9. Surge Immunity Test	28
10. Conducted Immunity Test.....	29
11. Voltage Dip, interruptions Immunity Test.....	30
12. hotographs	31
13. EMI Reduction method during compliance Testing	37
Appendix A Circuit diagram, block diagram, User Manual	
Appendix B Doc	

1. Test Report Certification

Applicant : ZIPPY TECHNOLOGY CORP.

Manufacturer : ZIPPY TECHNOLOGY CORP.

EUT Description : Switching power supply

- (A) FCC ID : N/A
- (B) Model No. : R3G-6650P
- (C) Serial No. : N/A
- (D) Power Supply : 115Vac/60Hz,230Vac/50Hz

MEASUREMENT PROCEDURE USED :

EN50082-1 RULES AND IEC 801 SERIES REGULATIONS
EN 55022 RULES

THE DEVICE DESCRIBED ABOVE WAS TESTED BY ZIPPY SHIN JIUII CORP. TO DETERMINE THE SEVERITY LEVELS THE DEVICE CAN ENDURE AND ITS PERFORMANCE CRITERION.

THE MEASUREMENT RESULTS ARE CONTAINED IN THIS TEST REPORT AND ZIPPY SHIN JIUH CORP. IS ASSUMED FULL RESPONSIBILITY FOR THE ACCURACY AND COMPLETENESS OF THESE MEASUREMENT.

ALSO, THIS REPORT SHOWS THAT THE EUT TO BE TECHNICALLY COMPLIANT WITH THE EN STANDARD.

Test Dated : MAY,23,2002

Test Engineer : *Karen*

Approve & Authorized Signer : *Shin Juii*

2. General Information

2.1 Production Description

Description : Switching power supply

Model Number : R3G-6650P

Applicant : ZIPPY TECHNOLOGY CORP.

Address : 10F, No. 50, MIN CHYUAN RD. SHIN-TIEN, TAIPEI HSIEN
TAIWAN, R.O.C

FCC ID : N/A

Data Cable : N/A

PowerCord : Non-Shielded, detachable, 1.5m

2.2 Tested System Details

The FCC IDs for all equipment, plus descriptions of all cables used in the tested system (including inserted cards, which have grants) are:

2.2.1 Resistor Load

Model Number	:	ELECTRONIC LOAD
Serial Number	:	N/A
FCC ID	:	N/A
Manufacturer	:	ZIPPY
Power	:	650W

2.3 Test Methodology

EMI Test:

Both conducted and radiated testing were performed according to the procedures in EN 55022
Radiated testing was performed at an antenna to EUT distance of 10 meters.

EMS Test:

Performed according to procedures in EN 61000(IEC 801)

2.4 Test Facility

ZIPPY TECHNOLOGY CORP.
10F, No. 50, MIN CHYUAN RD.
SHIN-TIEN, TAIPEI HSIEN
TAIWAN, R.O.C

3. Electronic-Magnetic Interference Test

3.1 Conducted Power Line Test

3.1.1 TEST Equipment's

The following test equipment's are used during the conducted power line tests:

Item	Instrument	Manufacture	Type No:	Last Calibration
1	TEST RECEIVER	ROHDE & SCHWARZ	ESHS30	MAY.2001
2	LISN	ROHDE & SCHWARZ	ENV4200	MAY.2001
3	COMPUTER	Acer	Power8000	N/A
4	PRINTER	EPSON	5700L	N/A
7	SHIELDED ROOM 4.0M*3.0M*3M			N/A

3.1.2 Block Diagram of Test Setup

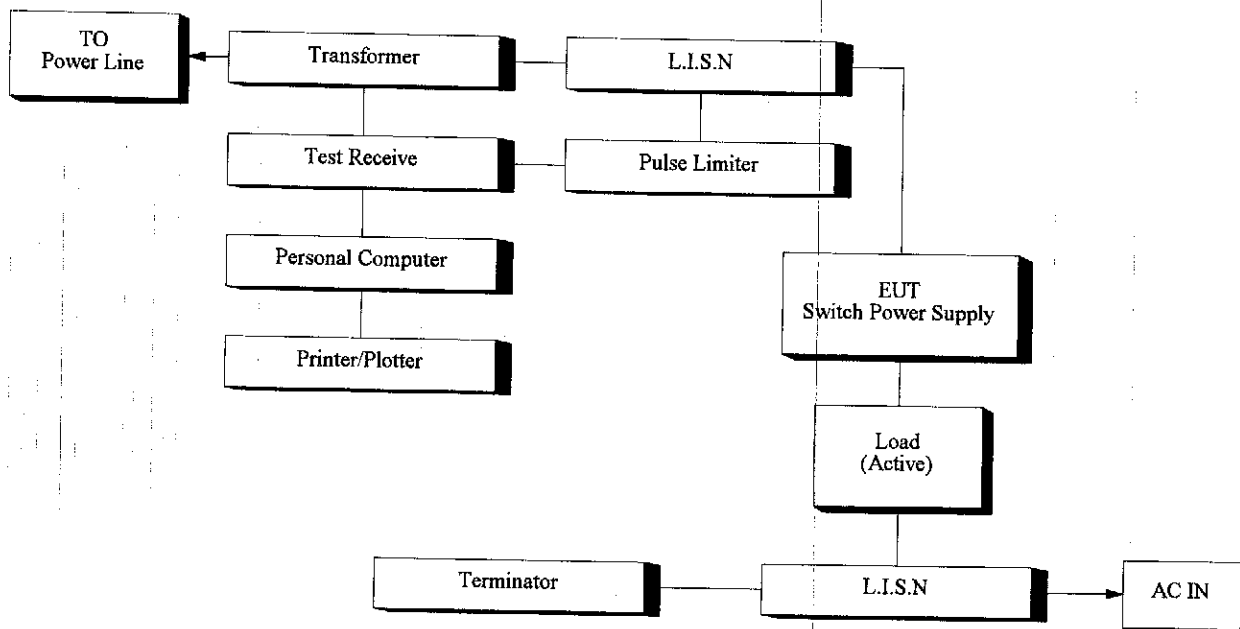

3.1.3 Conducted Powerline Emission Limit

Maximum RF Line Voltage dB(uV)		
Frequency	Class B	
MHz	QUASI-PEAK	AVERAGE
0.15 - 0.50	66-56	56-46
0.50 - 5.0	56	46
5.0 - 30	60	50

Remarks: In the Above Table, the tighter limit applies at the band edges.

3.1.4 EUT Configuration on Measurement

The equipment's which is listed 3.2 are installed on Conducted Power Line Test to meet the Commission requirement and operating in a manner which tends to maximize its emission characteristics in a normal application.

3.1.5 EUT Exercise Software

The EUT exercise program used during conducted testing was designed to exercise the EUT in a manner similar to a typical use. The exercise sequence is listed as below:

3.1.5.1 Setup the EUT and simulators as shown on 3.2.

3.1.5.2 Turn on the power of all equipment's.

3.1.6 Conducted Emission Data

The measurement range of conducted emission which is from 0.15 MHz to 30 MHz was investigated. The initial step in collecting conducted data is a spectrum analyzer peak scan of the measurement range for all the test modes. Then the worst modes were reported the following data pages.

ZIPPY EMC LAB

conduction test

20 May 2002 14:08

EUT: R3G-6650P SPS (2U)
 Manuf: ZIPPY TECH CO.,LTD
 Op Cond: FULL LOAD
 Operator:
 Test Spec: EN55022 -- Class B
 Comment: Load Condition (27 39 1 1 30 2.5)
 L220V

Scan Settings

(3 Ranges)

Frequencies			Receiver Settings					
Start	Stop	Step	IF BW	Detector	M-Time	Atten	Preamp	OpRge
150kHz	500kHz	10kHz	10kHz	QP+AV	1msec	Auto	OFF	60dB
500kHz	5MHz	20kHz	10kHz	QP+AV	1msec	Auto	OFF	60dB
5MHz	30MHz	50kHz	10kHz	QP+AV	1msec	Auto	OFF	60dB

Transducer	No.	Start	Stop	Name
	1	150kHz	30MHz	CEB

Prescan Measurement:
 Detectors: X QP / + AV
 Meas Time: see scan settings
 Peaks: 8
 Acc Margin: 25 dB

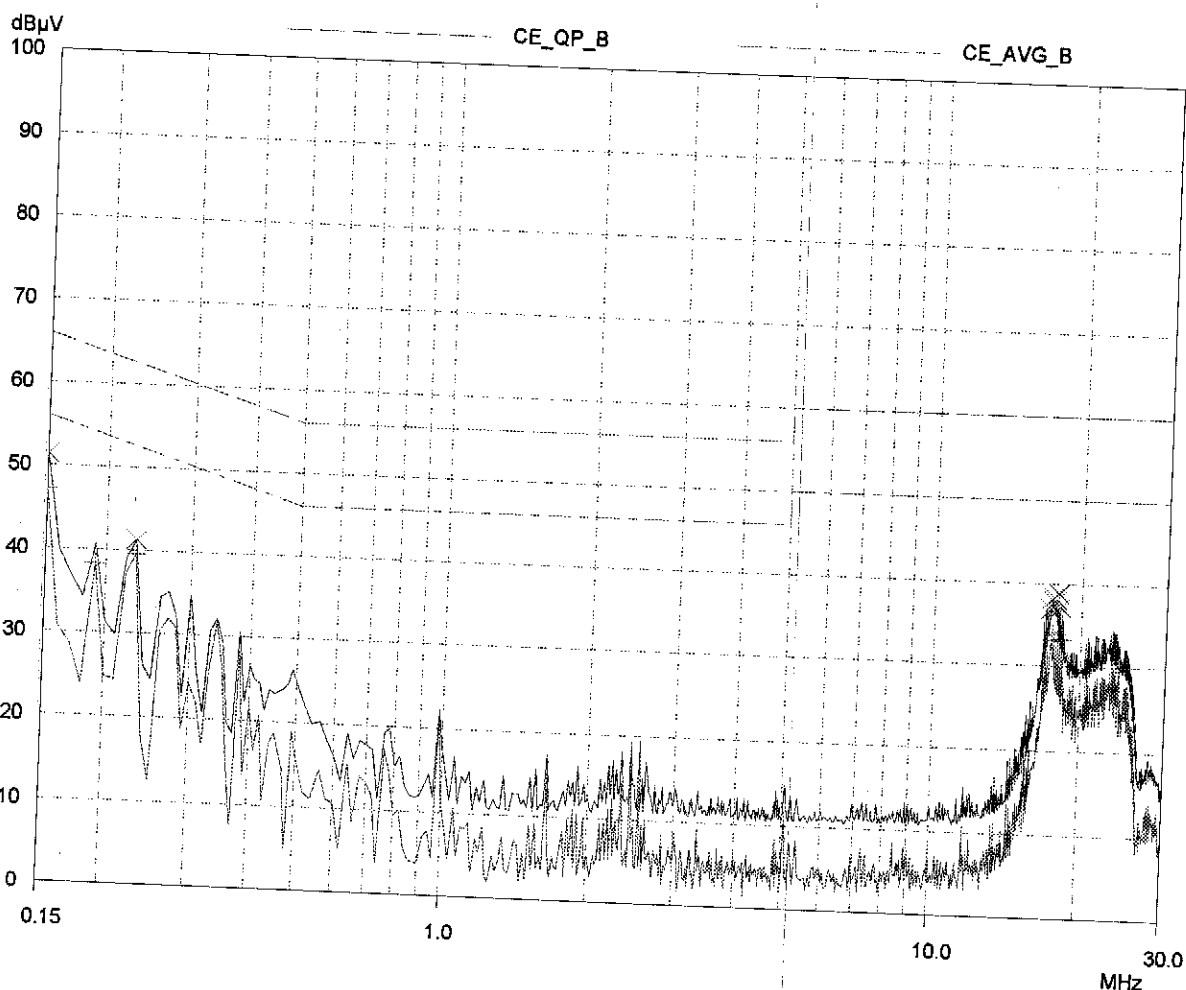

ZIPPY EMC LAB

conduction test

20 May 2002 14:08

EUT: R3G-6650P SPS (2U)
 Manuf: ZIPPY TECH CO.,LTD
 Op Cond: FULL LOAD
 Operator:
 Test Spec: EN55022 - Class B
 Comment: Load Condition (27 39 1 1 30 2.5)
 L220V

Scan Settings (3 Ranges)

Start	Stop	Step	IF BW	Detector
150kHz	500kHz	10kHz	10kHz	QP+AV
500kHz	5MHz	20kHz	10kHz	QP+AV
5MHz	30MHz	50kHz	10kHz	QP+AV

Receiver Settings

M-Time	Atten	Preamp	OpRge
1msec	Auto	OFF	60dB
1msec	Auto	OFF	60dB
1msec	Auto	OFF	60dB

Transducer	No.	Start	Stop	Name
	1	150kHz	30MHz	CEB

Pre-scan Measurement:
 Detectors: X QP / + AV
 Meas Time: see scan settings
 Peaks: 8
 Acc Margin: 25 dB

Peak Search Results

Frequency MHz	QP Level dBµV	QP Limit dBµV	QP Delta dB	Phase	PE
0.15	51.42	66.00	14.58	N	gnd
0.23	41.23	62.45	21.22	N	gnd
17.25	36.91	60.00	23.09	N	gnd
17.4	38.30	60.00	21.70	N	gnd
17.6	37.77	60.00	22.23	N	gnd
17.75	38.02	60.00	21.98	N	gnd
17.9	38.83	60.00	21.17	N	gnd
18.05	37.13	60.00	22.87	N	gnd

Frequency MHz	AV Level dBµV	AV Limit dBµV	AV Delta dB	Phase	PE
0.15	47.16	56.00	8.84	N	gnd
0.19	38.28	54.04	15.76	N	gnd
0.23	39.53	52.45	12.92	N	gnd
17.4	34.01	50.00	15.99	N	gnd
17.6	33.00	50.00	17.00	N	gnd
17.9	33.79	50.00	16.21	N	gnd
18.05	33.10	50.00	16.90	N	gnd
18.2	33.20	50.00	16.80	N	gnd

* limit exceeded

Indicated Phase/PE shows Configuration of max. Emission

ZIPPY EMC LAB

20 May 2002 14:21

conduction test

EUT: R3G-6650P SPS (2U)
 Manuf: ZIPPY TECH CO..LTD
 Op Cond: FULL LOAD
 Operator:
 Test Spec: EN55022 – Class B
 Comment: Load Condition (27 39 1 1 30 2.5)
 N220V

Scan Settings

(3 Ranges)

Frequencies				Receiver Settings				
Start	Stop	Step	IF BW	Detector	M-Time	Atten	Preamp	OpRge
150kHz	500kHz	10kHz	10kHz	QP+AV	1msec	Auto	OFF	60dB
500kHz	5MHz	20kHz	10kHz	QP+AV	1msec	Auto	OFF	60dB
5MHz	30MHz	50kHz	10kHz	QP+AV	1msec	Auto	OFF	60dB

Transducer	No.	Start	Stop	Name
	1	150kHz	30MHz	CEB

Prescan Measurement:
 Detectors: X QP / + AV
 Meas Time: see scan settings
 Peaks: 8
 Acc Margin: 25 dB

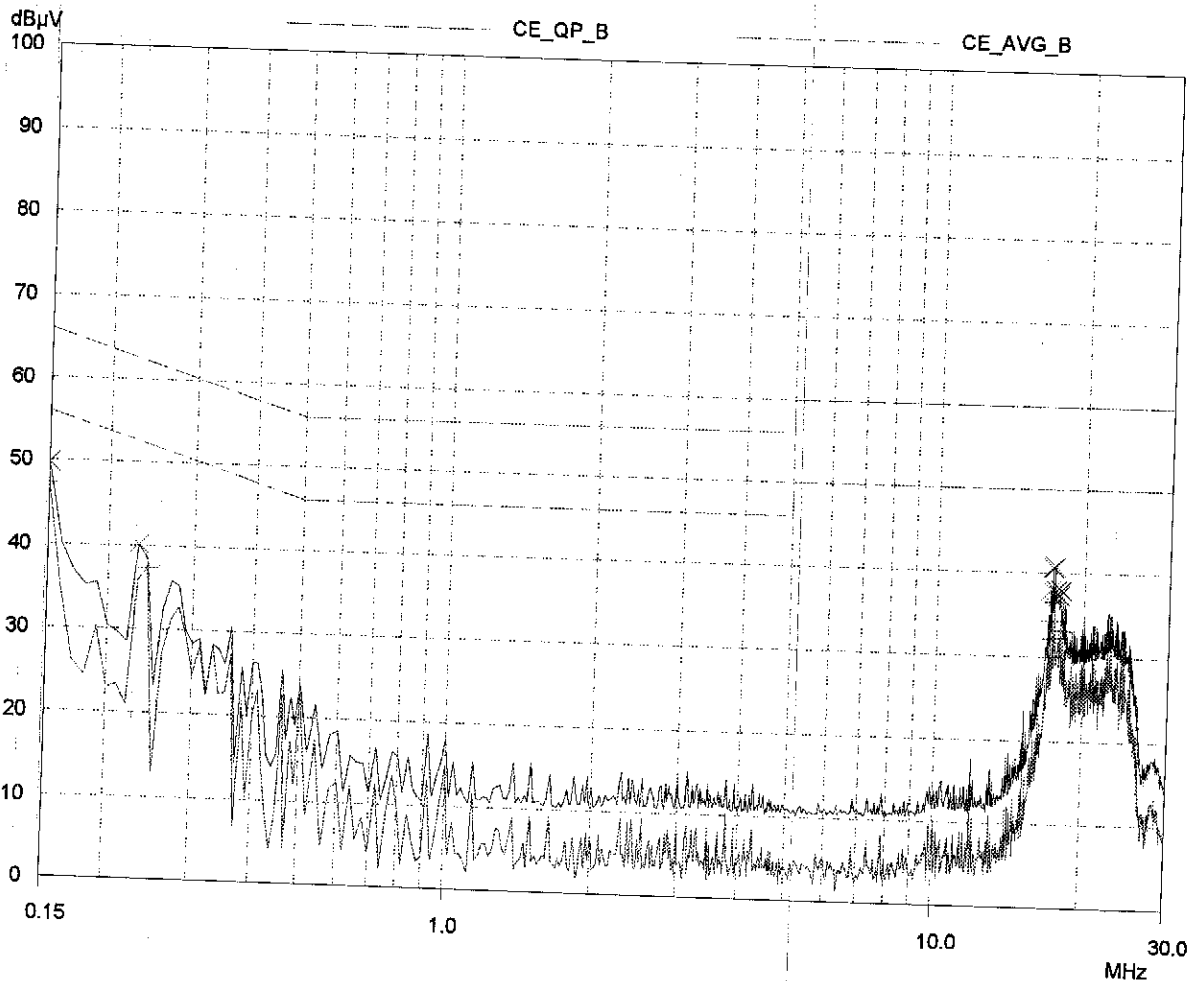

ZIPPY EMC LAB

conduction test

20 May 2002 14:21

EUT: R3G-6650P SPS (2U)
 Manuf: ZIPPY TECH CO..LTD
 Op Cond: FULL LOAD
 Operator:
 Test Spec: EN55022 -- Class B
 Comment: Load Condition (27 39 1 1 30 2.5)
 N220V

Scan Settings (3 Ranges)

Start	Stop	Step	IF BW	Detector
150kHz	500kHz	10kHz	10kHz	QP+AV
500kHz	5MHz	20kHz	10kHz	QP+AV
5MHz	30MHz	50kHz	10kHz	QP+AV

Receiver Settings

M-Time	Atten	Preamp	OpRge
1msec	Auto	OFF	60dB
1msec	Auto	OFF	60dB
1msec	Auto	OFF	60dB

Transducer	No.	Start	Stop	Name
	1	150kHz	30MHz	CEB

Prescan Measurement:
 Detectors: X QP / + AV
 Meas Time: see scan settings
 Peaks: 8
 Acc Margin: 25 dB

Peak Search Results

Frequency MHz	QP Level dBµV	QP Limit dBµV	QP Delta dB	Phase	PE
0.15	49.78	66.00	16.22	N	gnd
0.23	40.19	62.45	22.26	N	gnd
17.05	37.93	60.00	22.07	N	gnd
17.2	40.63	60.00	19.37	N	gnd
17.35	40.75	60.00	19.25	N	gnd
17.5	37.89	60.00	22.11	N	gnd
17.75	37.27	60.00	22.73	N	gnd
17.9	37.87	60.00	22.13	N	gnd

Frequency MHz	AV Level dBµV	AV Limit dBµV	AV Delta dB	Phase	PE
0.15	47.35	56.00	8.65	N	gnd
0.24	37.28	52.10	14.82	N	gnd
17.05	34.23	50.00	15.77	N	gnd
17.2	32.14	50.00	17.86	N	gnd
17.35	36.49	50.00	13.51	N	gnd
17.75	32.25	50.00	17.75	N	gnd
17.9	33.10	50.00	16.90	N	gnd
18.05	33.00	50.00	17.00	N	gnd

* limit exceeded

Indicated Phase/PE shows Configuration of max. Emission

3.2 Radiation Emission Test

3.2.1 Test Equipment

The following test equipment's are used during the radiated emission test:

Instrument	Manufacture	Type No:	Last Calibration
Spectrum Analyzer	<u>H.P</u>	<u>8594A</u>	May,2001
Test Receiver	<u>IFR System</u>	<u>A-7550</u>	Jun,2001
Preamplifier	<u>H.P</u>	<u>8447D</u>	May,2001
Biconical Ant.	<u>Emco</u>	<u>3110</u>	Jun,2001
Log-Periodic Ant.	<u>Emco</u>	<u>3146</u>	Jun,2001
Dipole Antenna	<u>Emco</u>	<u>3121C</u>	Nov,2000

3.2.2 Test Setup

3.2.2.1 Block Diagram of Connection between EUT and simulators

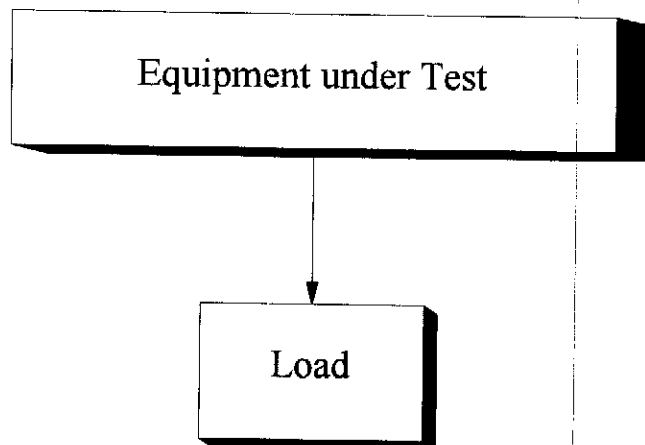

EUT: SWITCHING POWER SUPPLY

3.2.2.2 Open Field Test Site - description

The open field test site (OFTS) is designed to provide an environment in which repeatable tests of radiated emissions can be carried out.

It consists of a flat elliptical area as shown in the diagram below.

The equipment under test and the antenna are placed at the foci of the ellipse.

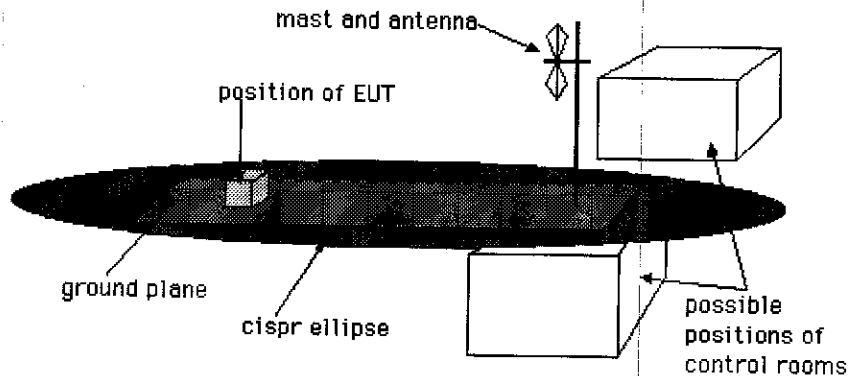

The antenna height should be remotely adjustable from 1m to 4m. Measuring instrumentation should be outside the ellipse at the position shown or in a room under the ground plane.

The whole or part of the site may be enclosed in an RF transparent building.

For precompliance testing a 3m test site with a fixed height antenna (at 1.5-2m height) and no metallic ground plane may be used. This may be a clear area on a car park or a grass area but should be away from large metallic structures.

3.2.3 Radiated Emission Limit

Class B Limits

Frequency	Distance	Field Strength
MHz	Meter	DB(uV/M)
30-230	10	30
230-1000	10	37

Remarks:

1. The tighter limit shall apply at the edge between two frequency bands.
2. Distance refers to the distance in meters between the measuring instrument antenna and the closed point of any part of the device or system.

3.2.4 EUT Configuration

The equipment's which is listed 4.2.1 are installed on Radiated Emission Test to meet the Commission requirement and operating in a manner which tends to maximize its emission characteristics in a normal application.

3.2.5 Operation Condition of EUT

Same as Conducted Power Line Test which is listed in 3.5.

3.2.6 Radiated Emission Data

The measurement range of radiated emission which is from 30 MHz to 1000 MHz was investigated. The initial step in collecting conducted data is a spectrum analyzer peak scan of the measurement range for all the test modes. Then the worst modes were reported the following data pages.

4.ESD Measurement

4.1 Test Equipment

The following test equipment's are used during the ESD test:

Instrument	Manufacture	Type No:	Last Calibration
ESD Simulator system	Keytek	MZ-15/EC	MAR,2001
Electronic Load	D-RAM	Load-2000	N/A

4.2 Test Setup

4.2.1 Block Diagram of Connections between EUT and simulators

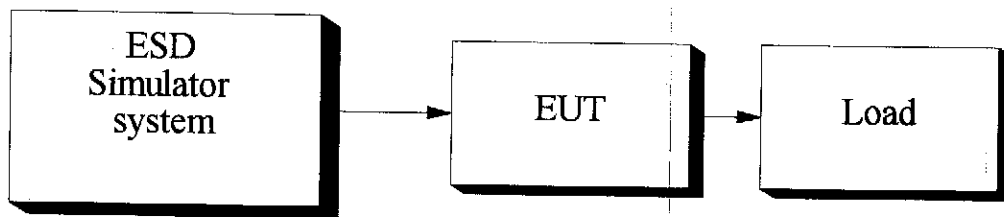

4.2.2 Test Setup of EUT

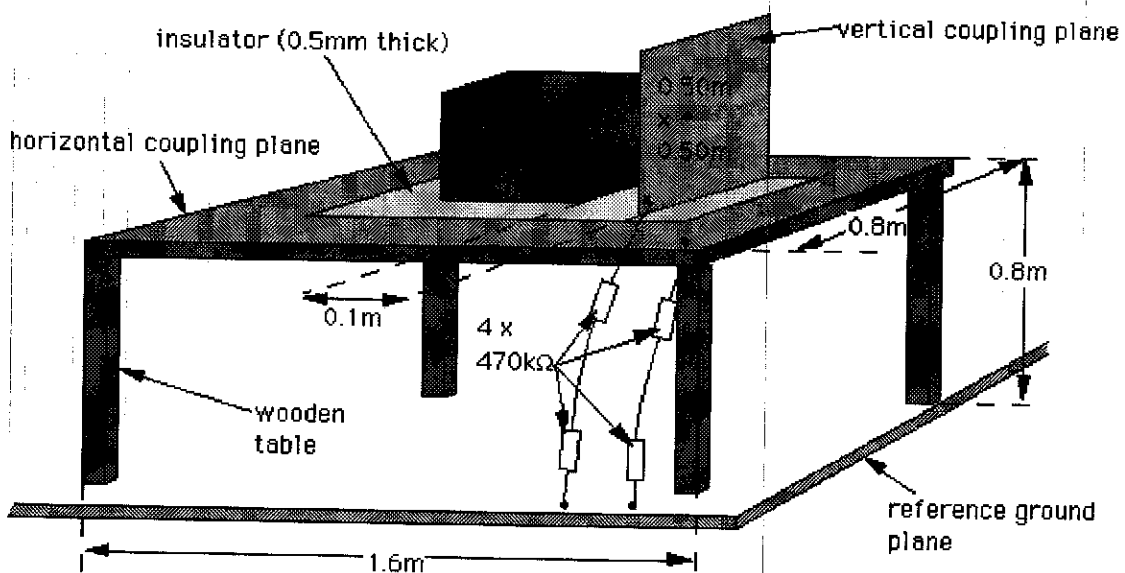

4.3 Severity Levels

LEVEL	TEST VOLTAGE CONTACT DISCHARGE	TEST VOLTAGE AIR DISCHARGE
1	2KV	2KV
2	4KV	4KV
3	6KV	6KV
4	8KV	8KV
X	SPECIAL	SPECIAL

4.4 EUT Operating Condition

1. Setup the EUT and Test Equipment as shown on 4.2
2. power on.

4.5 Test Procedure

Air Discharge:

This test was done above a non-conductive surfaces. The round discharge electrode about 30cm away will approach as fast as possible to touch test points of the EUT. Discharge happens before the contact. This procedure is repeated ten times on one selected location.

4.6 Test Method

According to IEC 61000-4-2

MODEL: R3G-6650P

REPORT NO: 02052301

4.7 Test Result

DATE OF TEST : MAY,21,2002

TEMPERATURE : 26°C

EUT : SWITCH POWER SUPPLY

HUMIDITY : 65%

TEST MODE : R3G-6650P

DISPLAY PATTERN: N/A

Item	Amount of discharge	Voltage	Results
Air discharge	500	+2KV	Pass
		-2KV	Pass
Air discharge	500	+4KV	Pass
		-4KV	Pass
Air discharge	500	+6KV	Pass
		-6KV	Pass
Air discharge	500	+8KV	Pass
		-8KV	Pass
Air discharge			
Air discharge			

Input Voltage:AC 230V/50Hz

5. Radiated Susceptibility Measurement

5.1 Test Equipment

The following test equipment's are used during the RS test:

Instrument	Manufacture	Type No:	Last Calibration
Signal generator	H.P	8657A	Dec.,20,2001
Power amplifier	A&R	100A100	Dec.,20,2001
Field strength meter	A&R	FM2000	Oct.,02,2001
Field strength sensor	A&R	EP2000	Oct.,02,2001
Power antenna	A&R	AT1080	Oct.,02,2001

5.2 Block Diagram of Test Setup

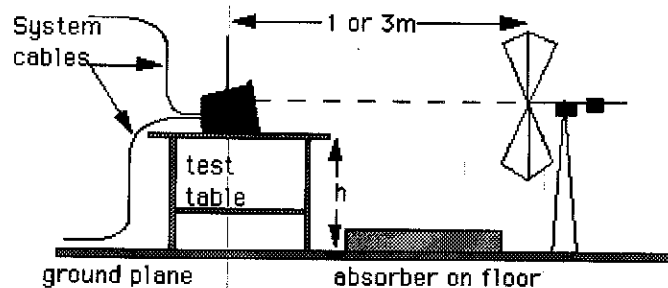
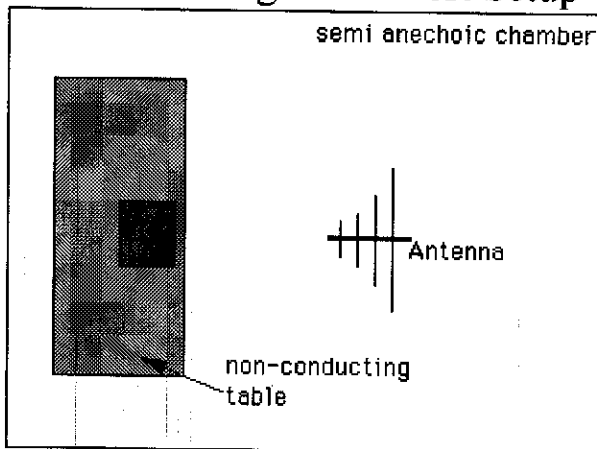

$h = 1\text{m}$ (IEC 801-3:1987) or
 0.8m (draft IEC 801.3)

Antennas-layout

For the upper frequency range of 200 to 1000 MHz, antennas are the normal method of producing the required field strength. This is also carried out in an anechoic chamber or a screened room. If a screened room is used it must be damped. The anechoic chamber should be used for compliance testing, the screened room may be used for precompliance testing. The fields in the screened room will not be as uniform as those obtainable in an anechoic chamber and will also not be as repeatable. The EUT is placed on a non-conductive table, 0.8 m above the reference ground plane, which in many cases will be the floor of a screened room. According to the standards, the EUT should be oriented so that its most sensitive side is facing the antenna. In practice it can be difficult to decide beforehand which is the most sensitive side, and in most cases, a series of tests will be required with the EUT in several orientations.

5.3 Severity Levels

LEVEL	FIELD STRENGTH V/M
1	1
2	3
3	10
X	SPECIAL

5.4 EUT Operating Condition

Same as section 4.4.

5.5 Test Procedure

The EUT and load are placed on a table which is 0.8 meter above ground. The field sensor is also placed on the same table to monitor field strength from transmitting antenna.

EUT is set 1 meter away from the transmitting antenna which is mounted on an antenna each time.

The antenna is fixed 1 meter above ground. Both horizontal and vertical polarization of the antenna are set on measurement.

In order to judge the EUT performance, a CCD camera is used to monitor EUT screen.

All the scanning conditions are as follows:

Condition of Test	Remarks
1. Field Strength	3 V/M Level 2
2. Radiated Signal	80% Amplitude Modulated with a 1KHz Tone
3. Scanning Frequency	80 MHz-1 GHz
4. Sweep Time of Radiated	0.0015 Decade/s

5.6 Test Method

According to IEC 61000-4-3

5.7 Test Result

DATE OF TEST : MAY,21,2002

TEMPERATURE : 26°C

EUT : SWITCH POWER SUPPLY

HUMIDITY : 65%

TEST MODE : R3G-6650P

DISPLAY PATTERN: N/A

Frequency Range (MHz)	Position (Angle)	Polarity (HorV)	Field Strength (V/M)	Results
80-1000	0° (Front)	H	3	Pass
80-1000	90° (Right)	H	3	Pass
80-1000	180° (Back)	H	3	Pass
80-1000	270° (Left)	H	3	Pass
80-1000	0° (Front)	V	3	Pass
80-1000	90° (Right)	V	3	Pass
80-1000	180° (Back)	V	3	Pass
80-1000	270° (Left)	V	3	Pass

Test Result : Criteria A

6. Electrical Fast Transient / Burst Measurement

6.1 Test Equipment

The following test equipment's are used during the EFT tests:

Instrument	Manufacturer	Type No.	Last Calibration
Fast Transient/Burst Generator	Keytek	EMCpro	MAR,2001

6.2 Block Diagram of Test Setup

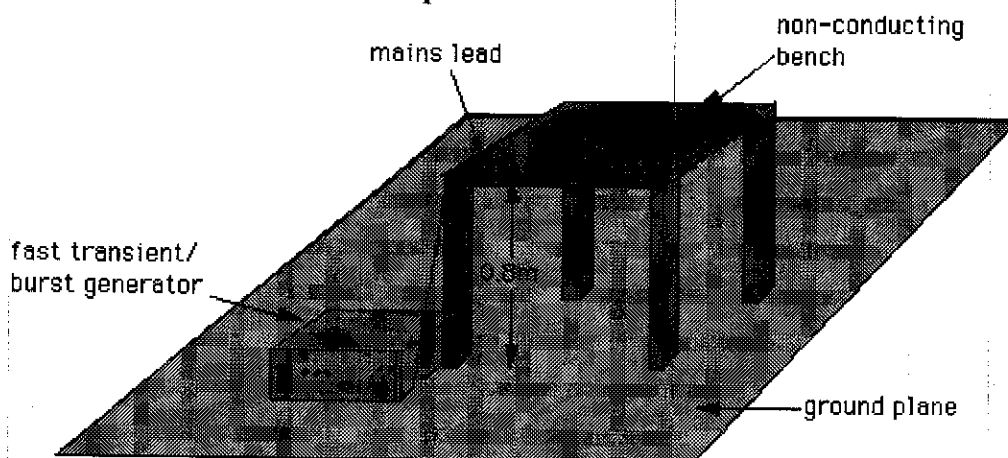

6.3 Severity Levels

Open Circuit Output Test Voltage +/- 10%	
Level	On power supply lines
1	0.5kv
2	1KV
3	2KV
4	4KV
X	SPECIAL

6.4 EUT Operation Condition

Same as section 4.4.

6.5 Test Procedure

The EUT and its load are placed on a table which is 0.8 meter above a metal ground plane measured 1m*1m min. And 0.65 mm thick min. And projected beyond the EUT by at least 0.1m on all sides.

The EUT is away from the walls of the test AC power line test is as follows:

For Ac power line test:

The EUT is connected to the power mains through a coupling device that directly couples the EFT interference signal.

Each of the Line and Neutral conductor is impressed with burst noise for 1 min.

6.6 Test Method

According to IEC 61000-4-4.

6.7 Test Result

DATE OF TEST : MAY,22,2002

TEMPERATURE : 26°C

EUT : SWITCH POWER SUPPLY

HUMIDITY : 65%

TEST MODE : R3G-6650P

DISPLAY PATTERN: N/A

Inject Line	Voltage KV	Inject time (sec)	Inject Method	Result
L1-PE	+1	60	DIRECT	PASS
L1-PE	-1	60	DIRECT	PASS
L2-PE	+1	60	DIRECT	PASS
L2-PE	-1	60	DIRECT	PASS
L1-L2	+1	60	DIRECT	PASS
L1-L2	-1	60	DIRECT	PASS

Input Voltage: AC 230 V/50Hz

7. HARMONIC CURRENT TEST

DATE OF TEST : MAY,21,2002

TEMPERATURE : 26°C

EUT : SWITCH POWER SUPPLY

HUMIDITY : 65%

TEST MODE : R3G-6650P

DISPLAY PATTERN: N/A

Item	Reading LeveA		Item	Reading LeveA	
	A	Limites		A	Limites
1	3.865				
3	0.433	2.300			
5	0.114	1.140			
7	0.057	0.770			
9	0.038	0.400			
11	0.021	0.308			
13	0.018	0.210			
15	0.013	0.150			
17	0.024	0.132			
19	0.024	0.118			
21	0.023	0.107			
23	0.020	0.098			
25	0.020	0.090			
27	0.013	0.083			
29	0.011	0.078			
31	0.009	0.073			
33	0.004	0.068			
35	0.005	0.064			
37	0.006	0.061			
39	0.004	0.058			



ANALYZER 6630

2002.05.21 08:58:30

Waveform M1

Note:

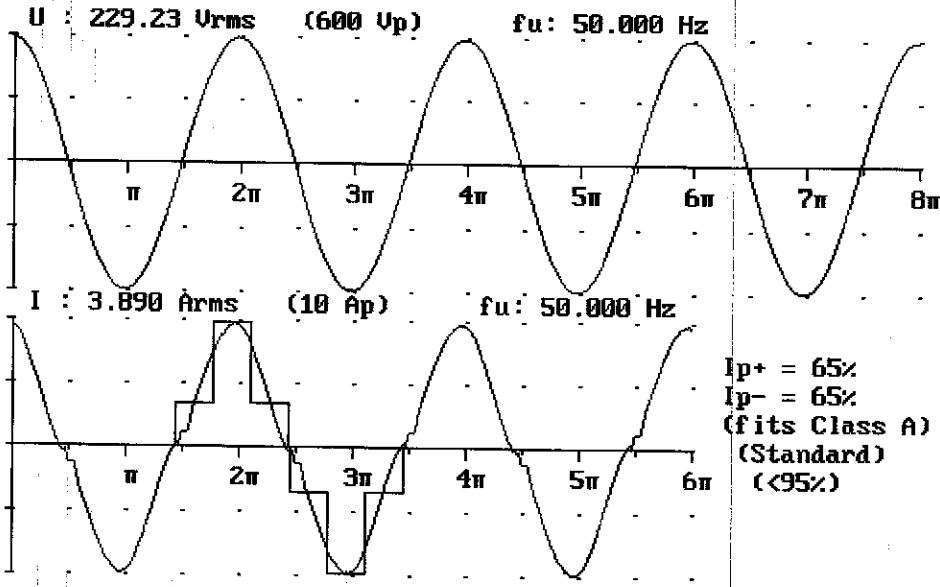

Next measure

Zoom Voltage

Zoom Current

Write to disk

Data cursor

Appl: EUROPE (1611_01)



ANALYZER 6630

2002.05.21 08:59:55

Current Harmonics

Setup: CLASS_D
Live
Module: M1

Gen setting: 1(1) U : 229.26 V fu: 49.999 Hz
Analysed periods: 4 I : 3.892 A P: 0.880 kW
Limit: Class D (Standard) I1: 3.865 A

Note:
THD=11.84 % (PF=0.986) PASSED

No	A	Lim A	No	A	Lim A	No	A	Lim A
1	3.865		15	0.013	0.150	29	0.011	0.078
2	0.015		16	0.001		30	0.001	
3	0.433	2.300	17	0.024	0.132	31	0.009	0.073
4	0.002		18	0.000		32	0.001	
5	0.114	1.140	19	0.024	0.118	33	0.004	0.068
6	0.003		20	0.000		34	0.001	
7	0.057	0.770	21	0.023	0.107	35	0.005	0.064
8	0.003		22	0.001		36	0.000	
9	0.038	0.400	23	0.020	0.098	37	0.006	0.061
10	0.001		24	0.000		38	0.001	
11	0.021	0.308	25	0.020	0.090	39	0.004	0.058
12	0.002		26	0.000		40	0.001	
13	0.018	0.210	27	0.013	0.083			
14	0.001		28	0.001				

Current range: 10 Ap

Next measure

Change to bar graph

Relative current

Write to disk

Appl: EUROPE (1212_03)



ANALYZER 6630

2002.05.21 08:59:14

Current Harmonics

Setup: CLASS_D
Live
Module: M1

Gen setting: 1(1) U : 229.26 V fu: 49.999 Hz
Analysed periods: 4 I : 3.892 A P: 0.880 kW
Limit: Class D (Standard) I1: 3.865 A
Note:
THD=11.84 % (PF=0.986) PASSED

Next measure

Change to table

Relative current

Log scale

Write to disk

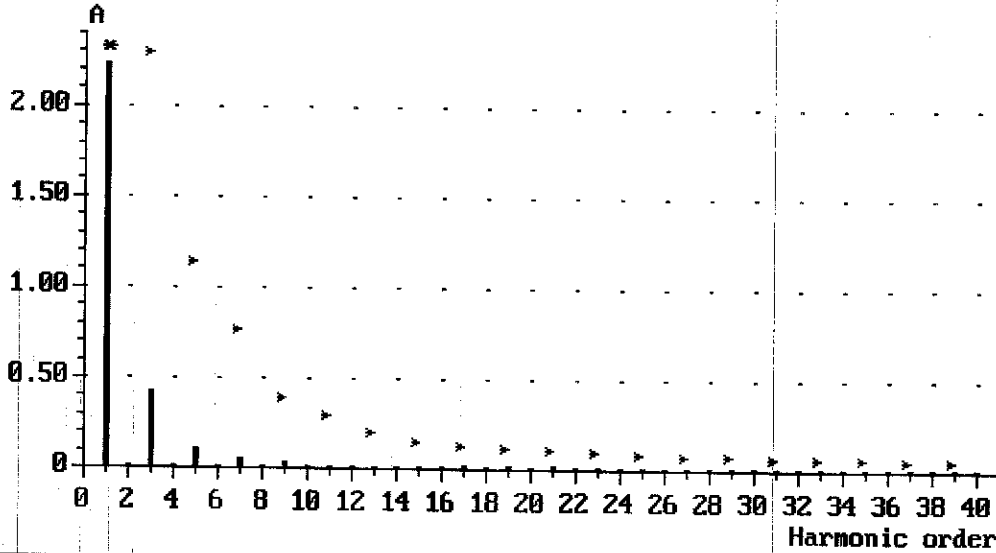

Appl: EUROPE

(1212_02)

MODEL: R3G-6650P

REPORT NO: 02052301

9. SURGE IMMUNITY TEST

DATE OF TEST : MAY,22,2002

TEMPERATURE : 26°C

EUT : SWITCH POWER SUPPLY

HUMIDITY : 65%

TEST MODE : R3G-6650P

DISPLAY PATTERN: N/A

Waveform	Voltage	Output:LC	Phs Ref	Phs Ang	Tests	Delay
12 Ohm	-2000V	MAINS:L1/PE	L1	0 deg.	5	60 sec
12 Ohm	-2000V	MAINS:L1/PE	L1	90 deg.	5	60 sec
12 Ohm	-2000V	MAINS:L1/PE	L1	270 deg.	5	60 sec
12 Ohm	2000V	MAINS:L1/PE	L1	0 deg.	5	60 sec
12 Ohm	2000V	MAINS:L1/PE	L1	90 deg.	5	60 sec
12 Ohm	2000V	MAINS:L1/PE	L1	270 deg.	5	60 sec
12 Ohm	-2000V	MAINS:L2/PE	L1	0 deg.	5	60 sec
12 Ohm	-2000V	MAINS:L2/PE	L1	90 deg.	5	60 sec
12 Ohm	-2000V	MAINS:L2/PE	L1	270 deg.	5	60 sec
12 Ohm	2000V	MAINS:L2/PE	L1	0 deg.	5	60 sec
12 Ohm	2000V	MAINS:L2/PE	L1	90 deg.	5	60 sec
12 Ohm	2000V	MAINS:L2/PE	L1	270 deg.	5	60 sec
2 Ohm	-1000V	MAINS:L1/L2	L1	0 deg.	5	60 sec
2 Ohm	-1000V	MAINS:L1/L2	L1	90 deg.	5	60 sec
2 Ohm	-1000V	MAINS:L1/L2	L1	270 deg.	5	60 sec
2 Ohm	1000V	MAINS:L1/L2	L1	0 deg.	5	60 sec
2 Ohm	1000V	MAINS:L1/L2	L1	90 deg.	5	60 sec
2 Ohm	1000V	MAINS:L1/L2	L1	270 deg.	5	60 sec

Test Result : Pass

MODEL: R3G-6650P

REPORT NO: 02052301

10. CONDUCTED IMMUNITY

DATE OF TEST : MAY,21,2002

TEMPERATURE : 26°C

EUT : SWITCH POWER SUPPLY

HUMIDITY : 65%

TEST MODE : R3G-6650P

DISPLAY PATTERN: N/A

Frequency Range (MHz)	Polarity (HorV)	Field Strength (V/M)	Results
0.15-80	H	3	Pass

INJECTION TYPE:

DIRECT CDN Type M3

TEST CONDITION:

Step: 1% Dwell Time: 3sec

Test result : Criteria A

11. VOLTAGE DIP,INTERRUPTIONS IMMUNITY

DATE OF TEST : MAY,22,2002TEMPERATURE : 26°CEUT : SWITCH POWER SUPPLYHUMIDITY : 65%TEST MODE : R3G-6650PDISPLAY PATTERN: N/A

Test Level	Phs Ang	Dur. Value	Duration	Tests	Delay
0% Short	0 deg.	0.5	cycle	3	10 sec
0% Short	90 deg.	0.5	cycle	3	10 sec
0% Short	180 deg.	0.5	cycle	3	10 sec
0% Short	270 deg.	0.5	cycle	3	10 sec
0% Open	0 deg.	0.5	cycle	3	10 sec
0% Open	90 deg.	0.5	cycle	3	10 sec
0% Open	180 deg.	0.5	cycle	3	10 sec
0% Open	270 deg.	0.5	cycle	3	10 sec
70% Dip	0 deg.	25.00	cycle	3	10 sec
70% Dip	90 deg.	25.00	cycle	3	10 sec
70% Dip	180 deg.	25.00	cycle	3	10 sec
70% Dip	270 deg.	25.00	cycle	3	10 sec
0% Open	0 deg.	250.00	cycle	3	10 sec
0% Open	90 deg.	250.00	cycle	3	10 sec
0% Open	180 deg.	250.00	cycle	3	10 sec
0% Open	270 deg.	250.00	cycle	3	10 sec

Test Result : Pass

12. Photographs

1. Front view of Power Supply
2. Back view of Power Supply

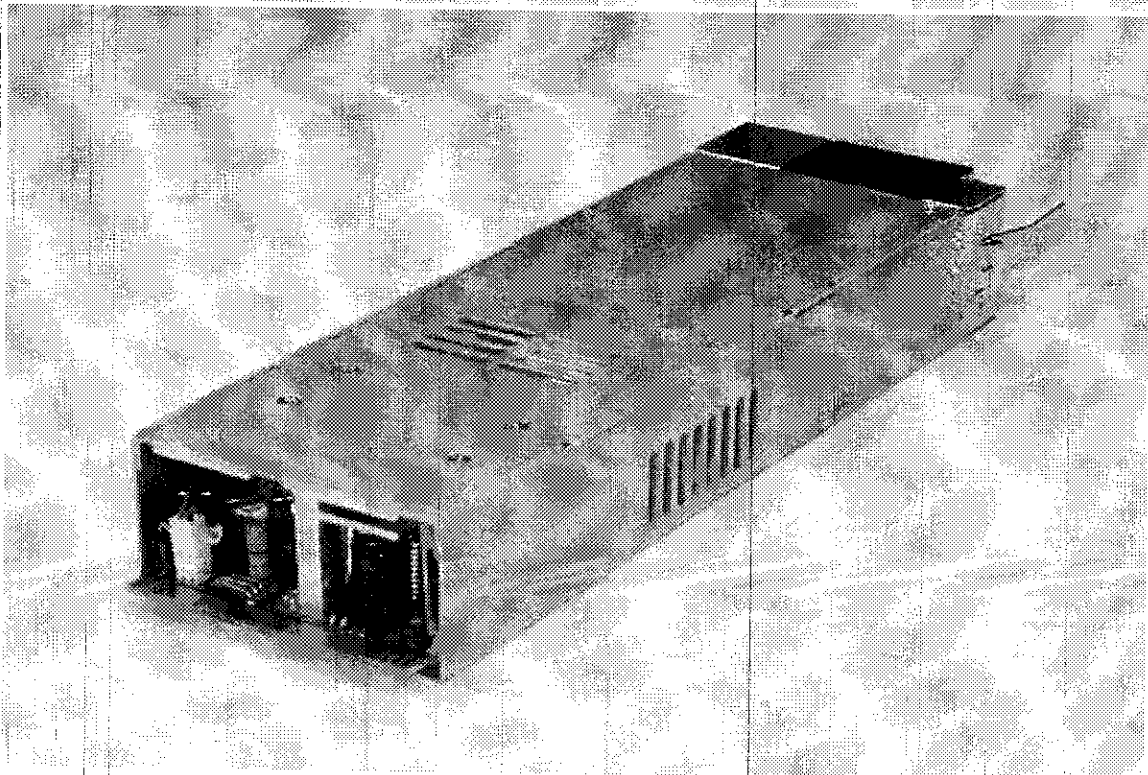
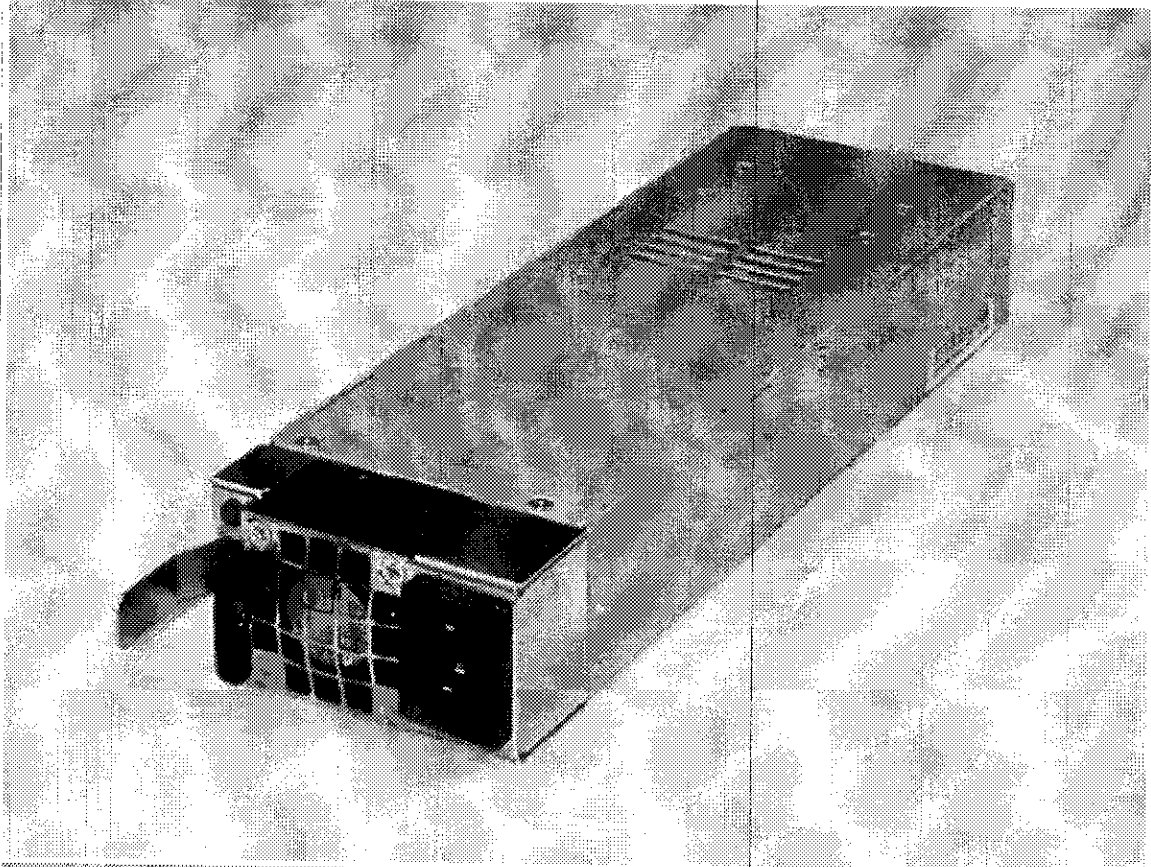

1. Front view of Power Supply
2. Back view of Power Supply

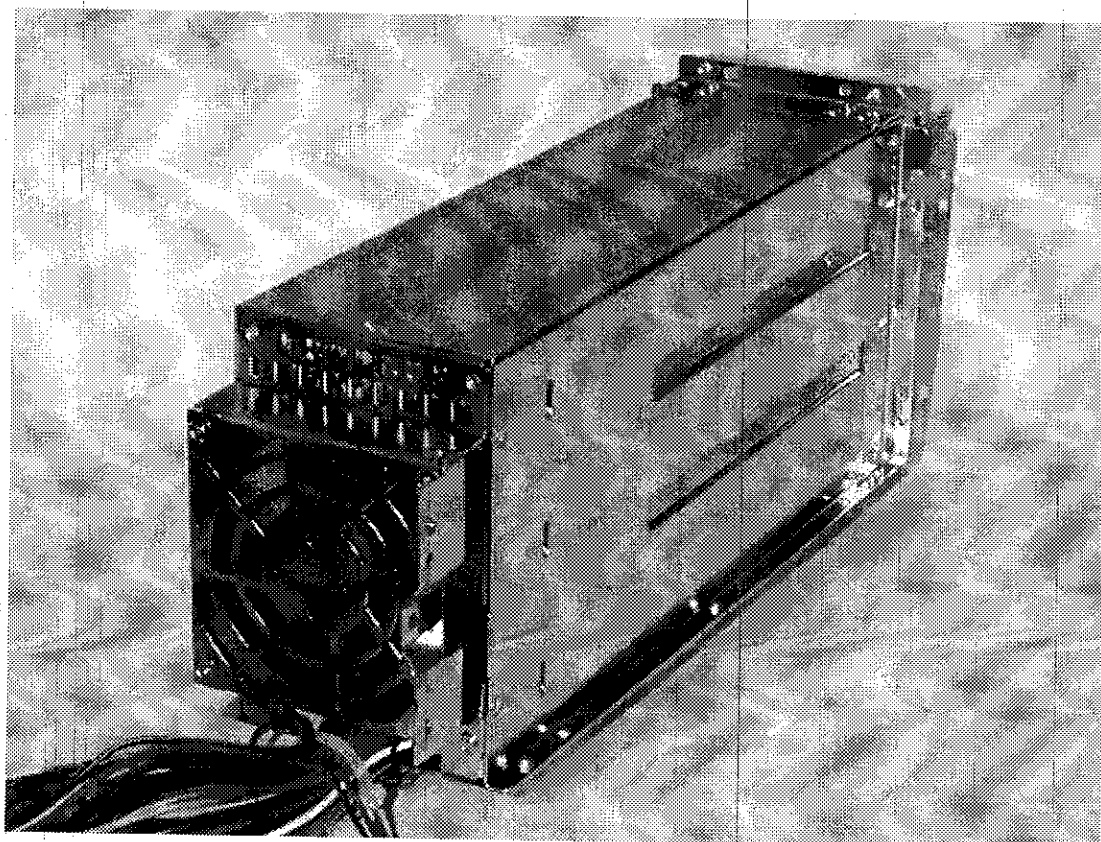
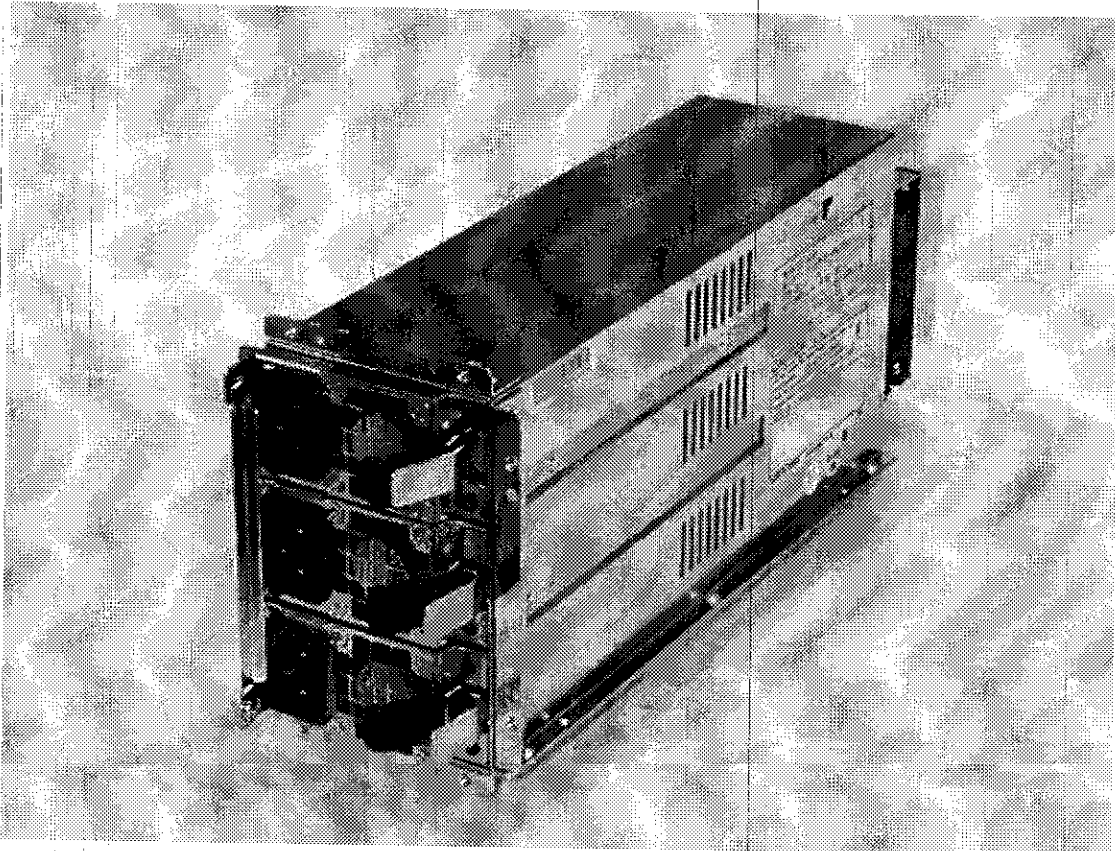

3. Component side of Mainboard

4. Solder side of Mainboard

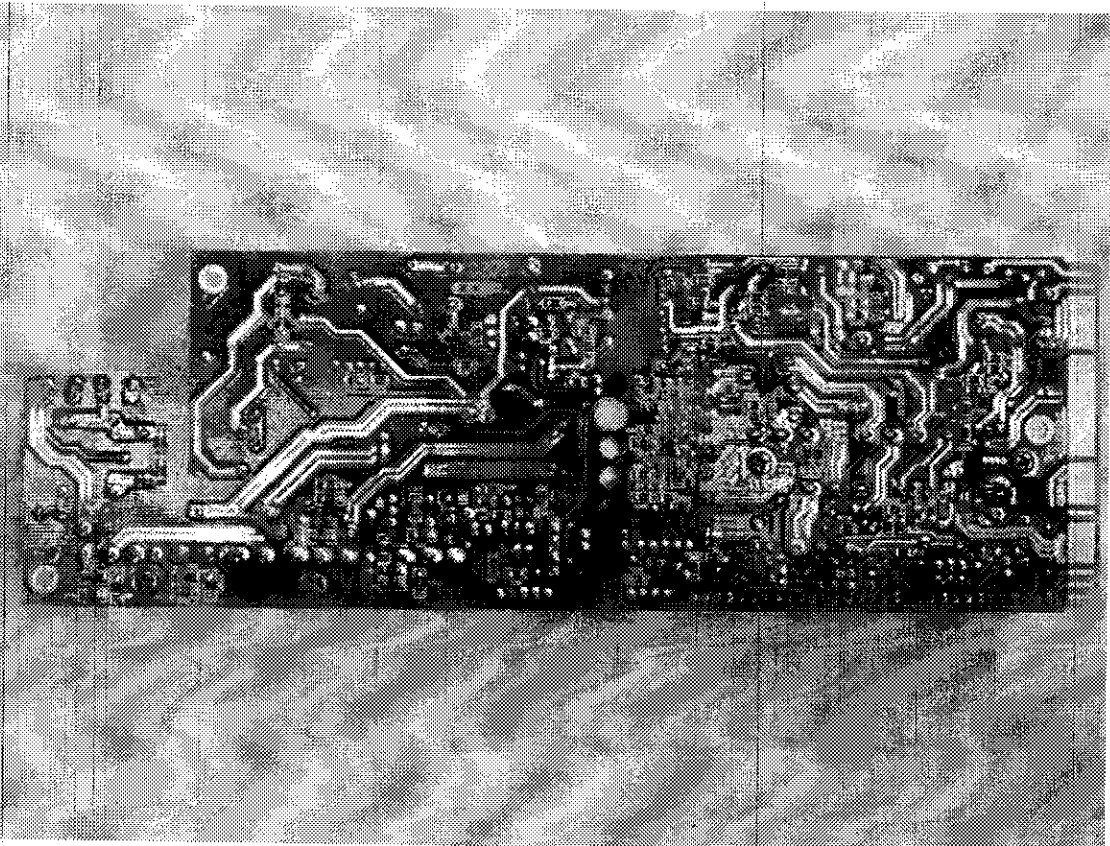
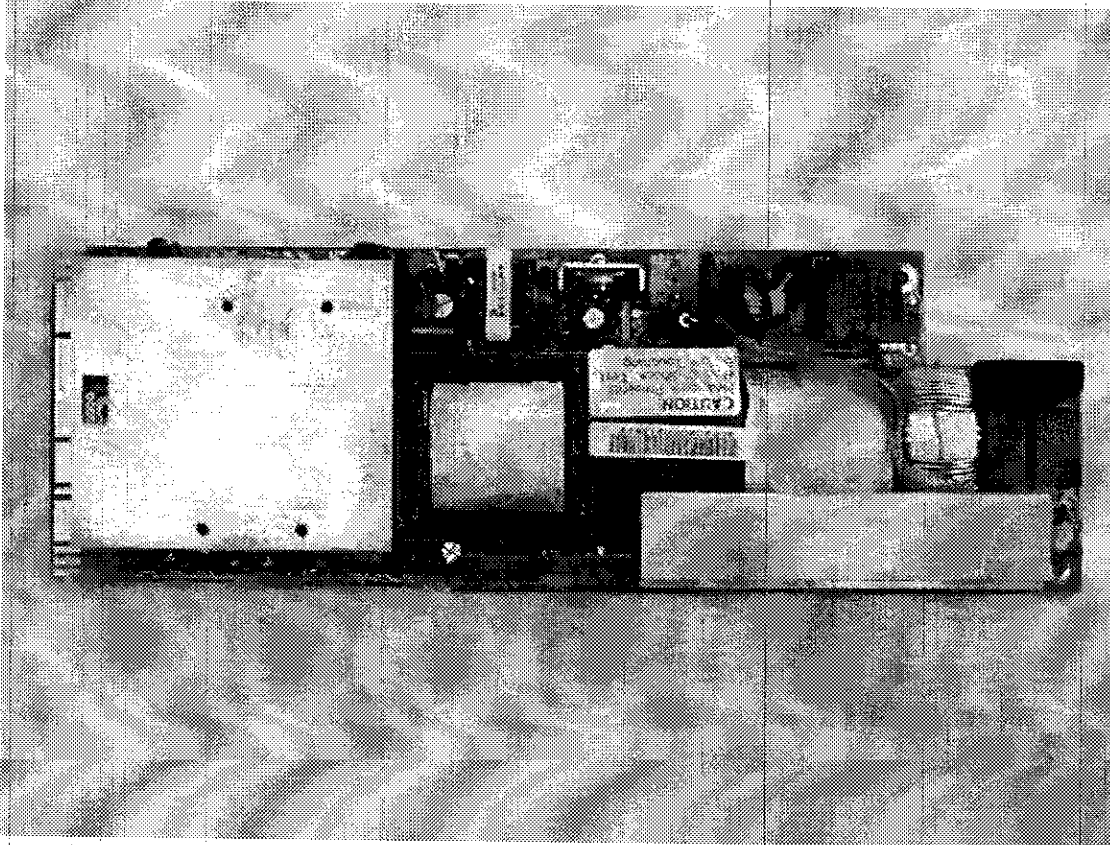

3.Component side of Mainboard

4.Solder side of Mainboard

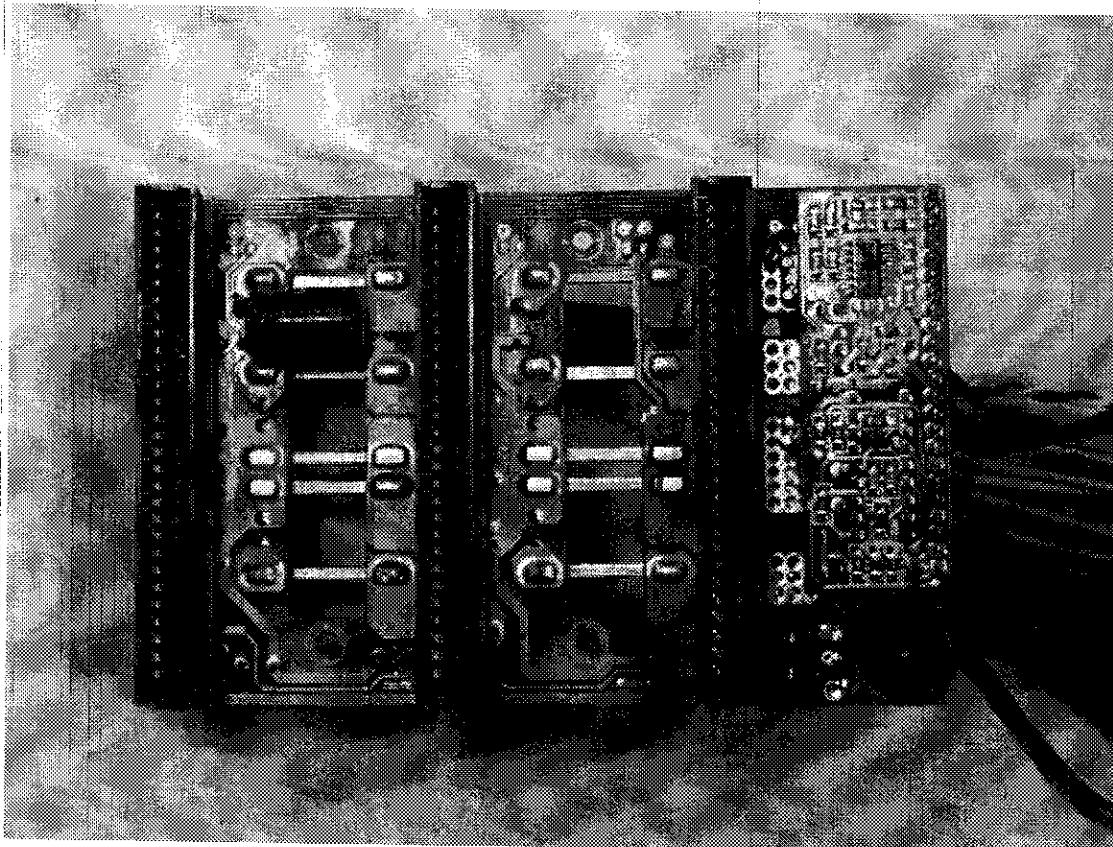
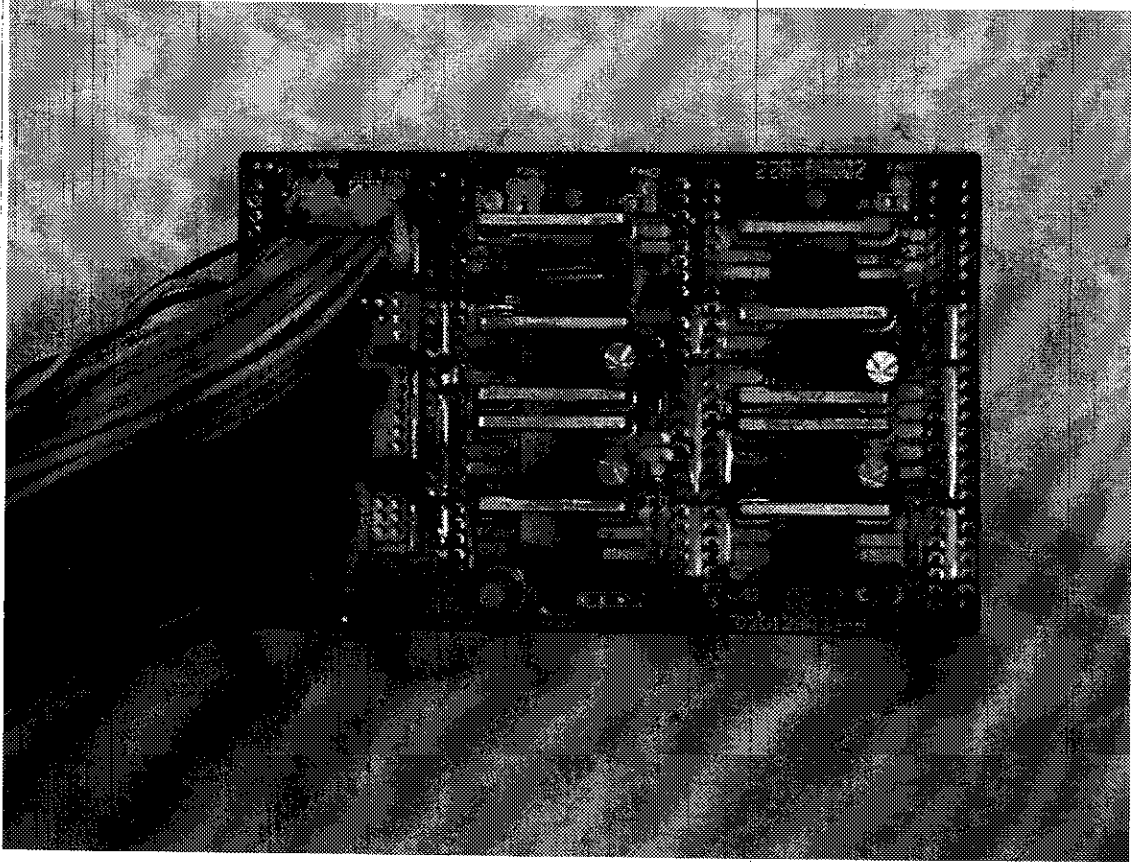

- 5. Inside view of Power Supply
- 6. Inside view of Power Supply

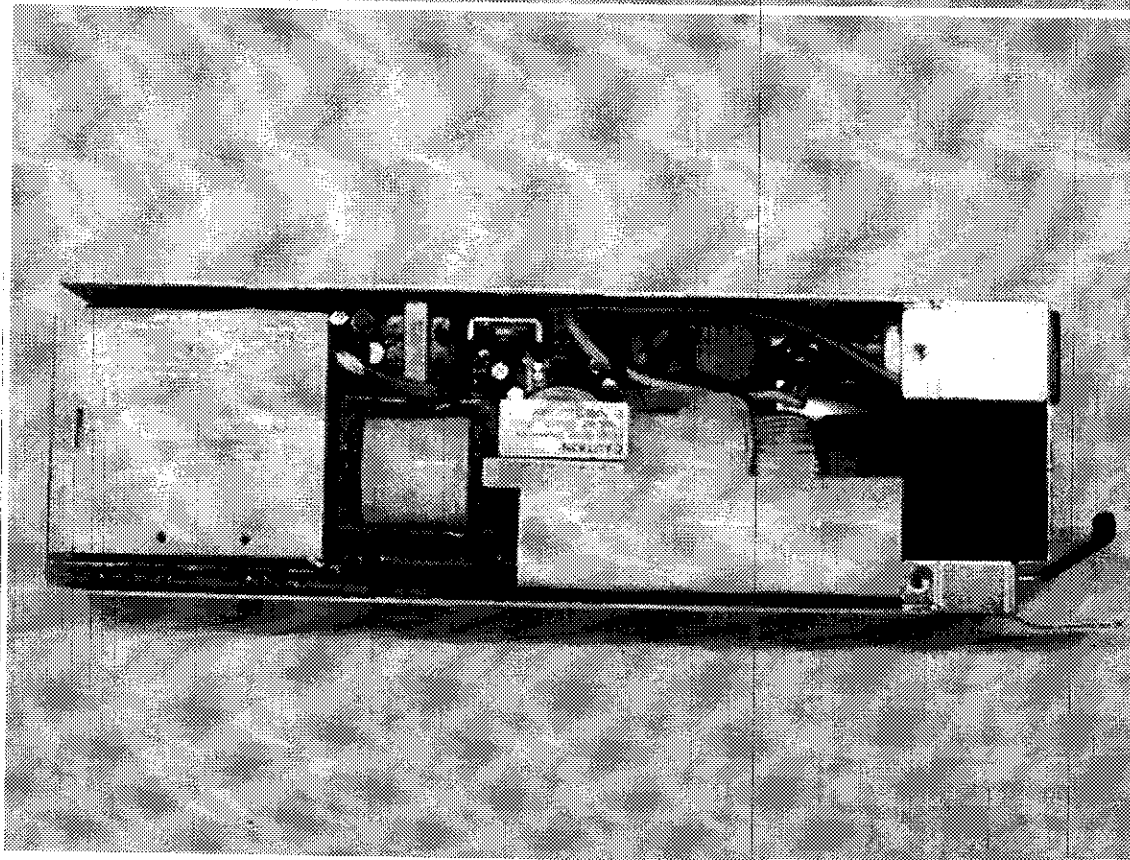
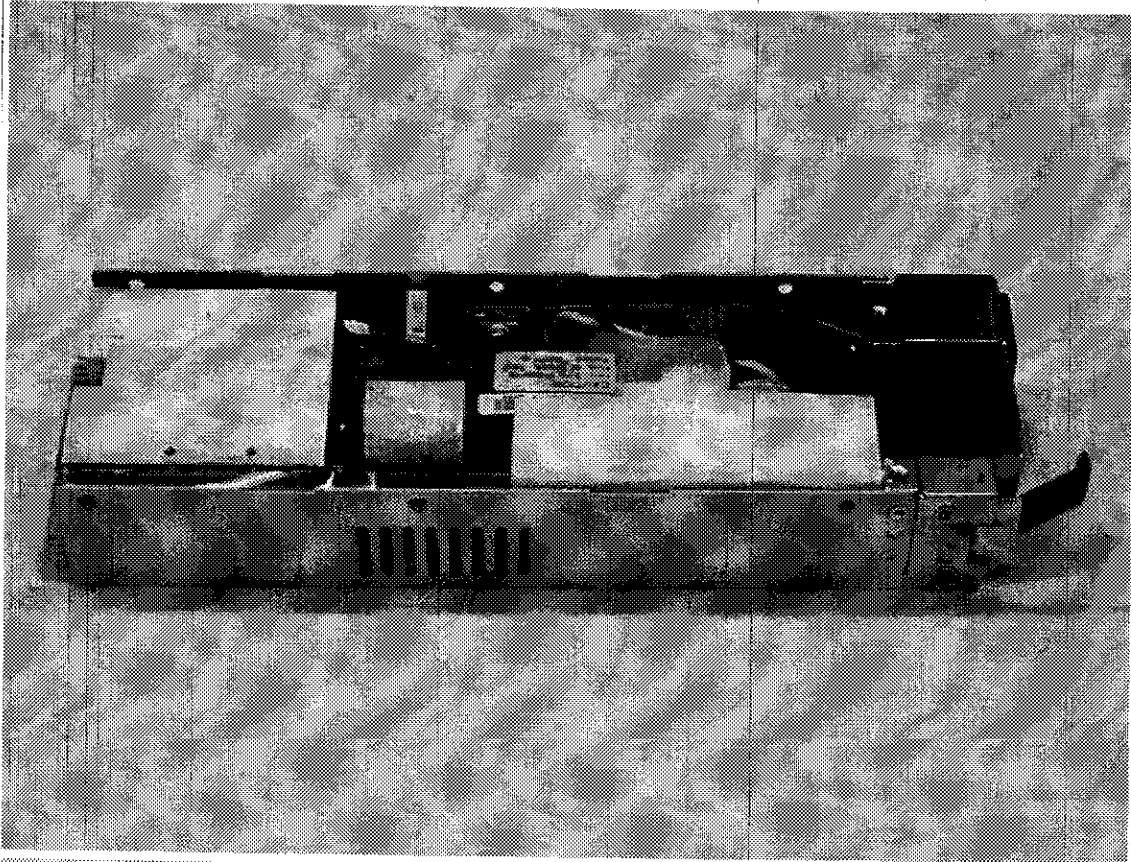

- 5. Inside view of Power Supply
- 6. Inside view of Power Supply

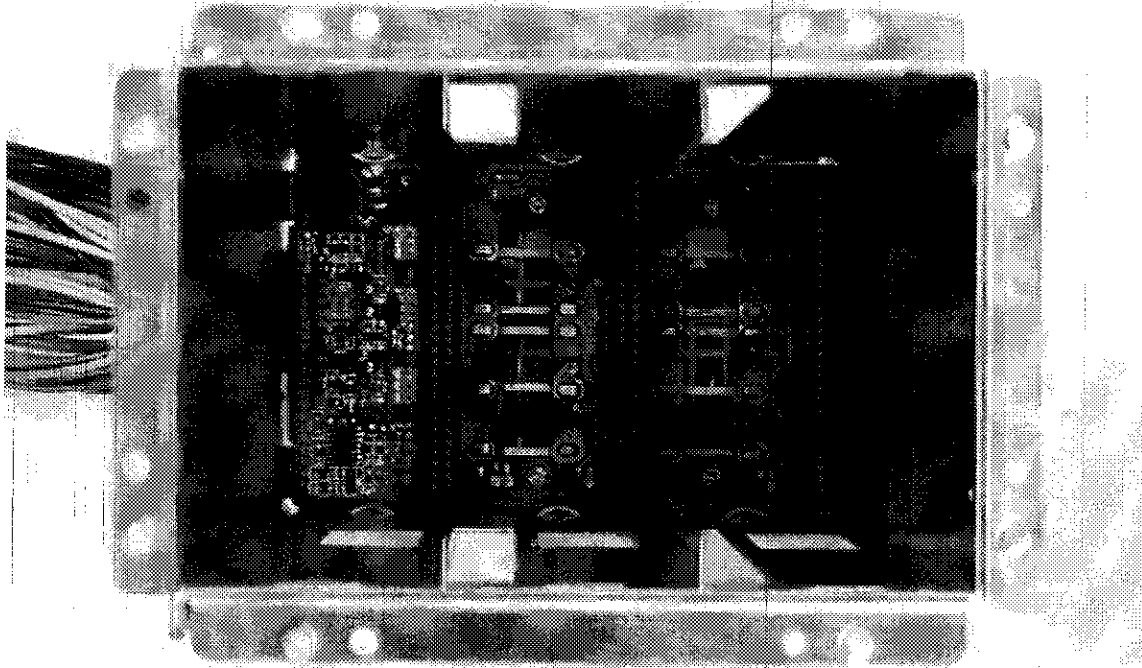

7. Test view

8. Test view

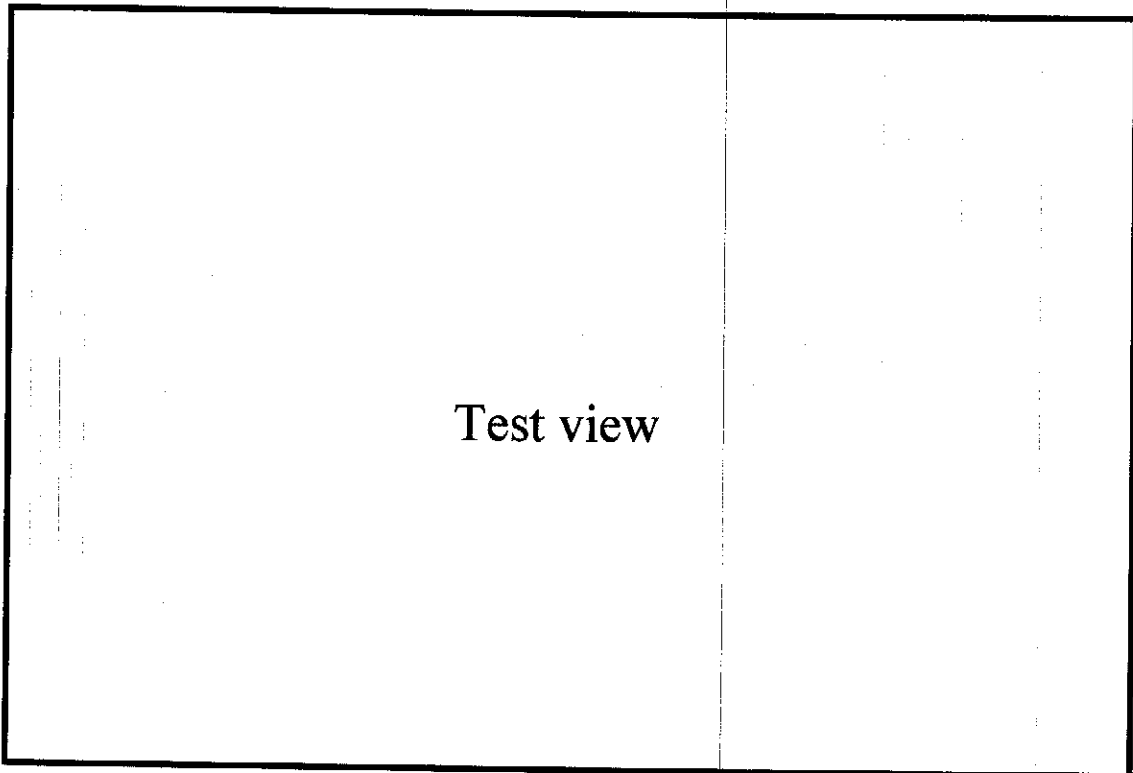
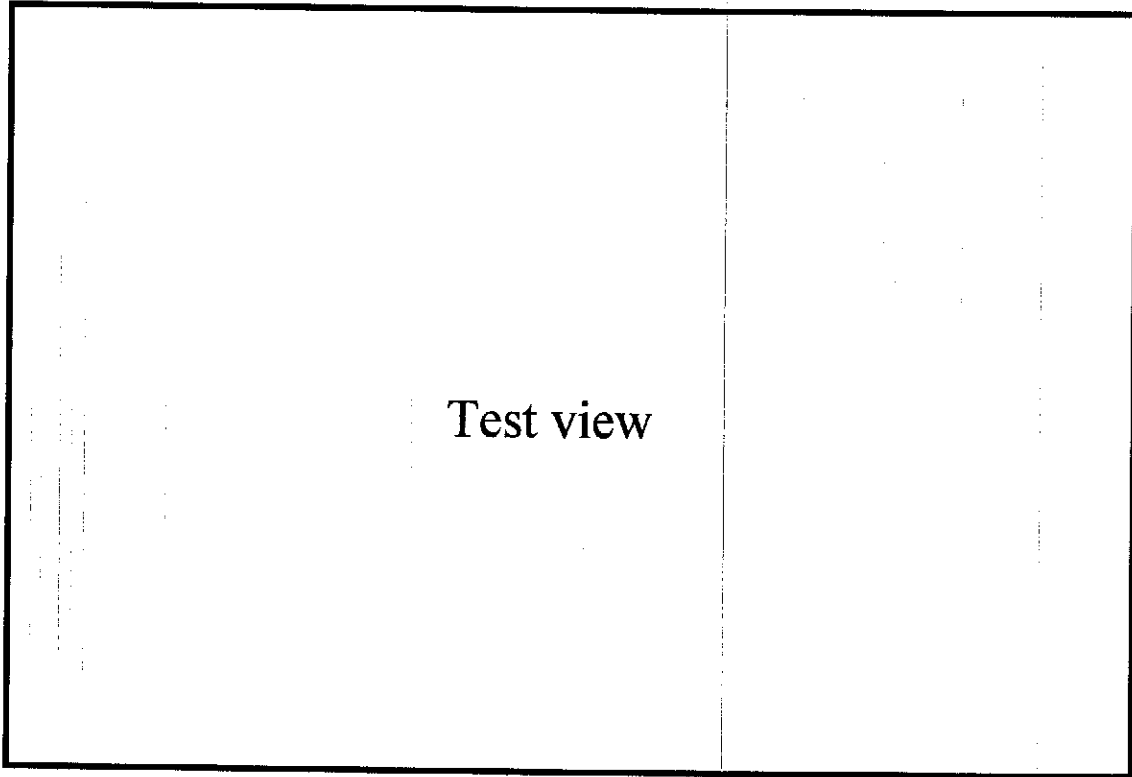

13.EMI Reduction Method During Compliance Testing

1.No modification was made during testing.