

Test Report
Model : YY-55XX

Tested to EN55022(1995)
Results from Preliminary Scan in 3 meter Chamber

Date: Aug 13, 2003

THIS TEST REPORT IS PROVIDED "AS IS" WITH NO WARRANTY WHATSOEVER, WHETHER EXPRESS, IMPLIED OR STATUTORY, INCLUDING BUT NOT LIMITED TO THOSE FOR NON-INFRINGEMENT OF INTELLECTUAL PROPERTY, MERCHANTABILITY OR SATISFACTORY QUALITY, FITNESS FOR ANY PARTICULAR PURPOSE, OR ANY WARRANTY OTHERWISE ARISING OUT OF ANY PROPOSAL, SPECIFICATION OR SAMPLE.

YEONG YANG ASSUMES NO RESPONSIBILITY FOR ANY ERRORS WHICH MAY APPEAR IN THIS DOCUMENT

Tested by Wallace Tsai

Date:Aug.13, 2003

Approved by Hubert Chou

Date:Aug.13, 2003

1. Introduction

The purpose of this evaluation is to present the results of the EMC Emissions tests on the Yeong Yang chassis. The testing was carried out by Yeong Yang at Hometek Technology Inc test facilities located at Hometek Technology Inc 13F, 2, Chien Ba Road, Chung Ho City 235 Taipei, Taiwan ROC

2. References

Radiated Emissions (as per EN55022:1995)
Power Line Conduction ((as per EN55022:1995)

3. Equipment Under Test (EUT)

3.1. EUT:

Yeong Yang YY-55XX Personal Computer Chassis



3.2. EUT Configuration

Description	Supplier	Model/Part Number
Chassis	Yeong Yang	YY-55XX
Power Supply	EVER POWER	HPC-300-202PFC
Chassis Fans	None	
Processor	Intel	Intel P4 3G, Quantity:1
Chipset	Intel	
Processor Thermal solution	Glacialtech	Igloo 4200, speed 3200RPM
Motherboard	AOPEN	AX4C MAX II
Memory	Kingston	DDR400 512MB, Quantity: 2
Hard Drive	Seagate	40G , Quantity: 1
CD ROM	ACER	40X , Quantity: 1
Floppy Drive	Mitsumi	D353M3 , Quantity: 1
Graphics Card	ASUS	V3800M

3.3. Support Equipment - 3 meter Chamber

Supplier	Description	Model/Part Number
AST	Keyboard	PS2/SK2000
AST	Keyboard	USB/SK2695
Logitech	Mouse	PS2/MS34
Logitech	Mouse	USB/BJ58
Hitachi	Monitor	CM769ET
HP	Printer	DJ400
ACEEX	Modem	1414
JASS	Speaker	J008

3.4. EUT Comments

EUT tested with, 3.0GHz Intel Pentium 4 Processors with active heat sink and fan. An I/O shield was supplied with motherboard and used in this chassis.

3.5. Software

The program used to exercise the EUT was the EMC test software EMCTEST.exe and EMITEST.exe which was running under Microsoft Windows XP. Video resolution was set at 800x600. *The EMC test software version is designed to exercise the various EUT components in a manner similar to typical use*

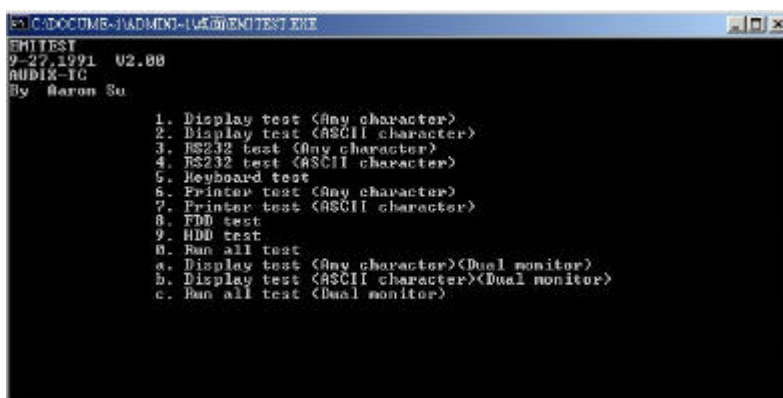
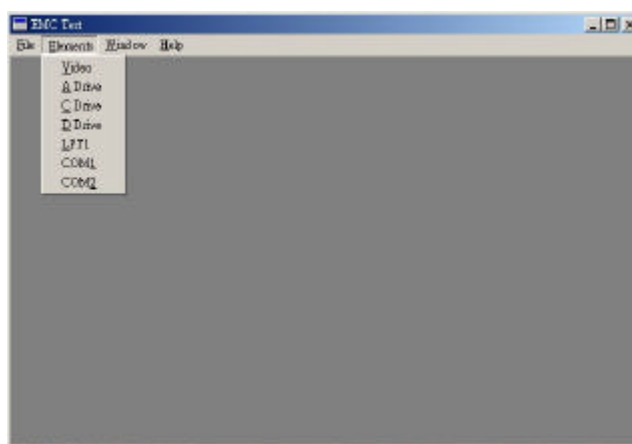

4. Test Result (Radiated Emissions)

4.1. Test Setup

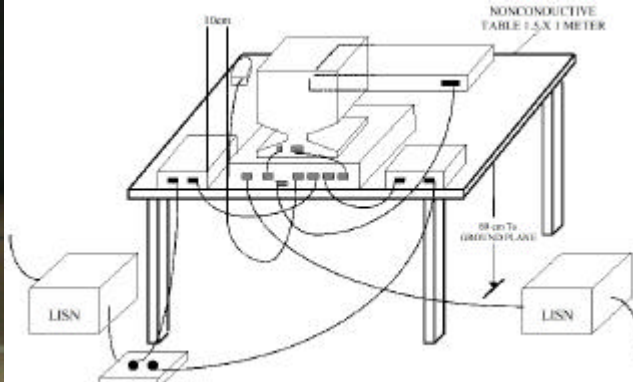

Figure 4.1.1. Generic Test set up for the Yeong Yang YY-55XX Personal Computer chassis

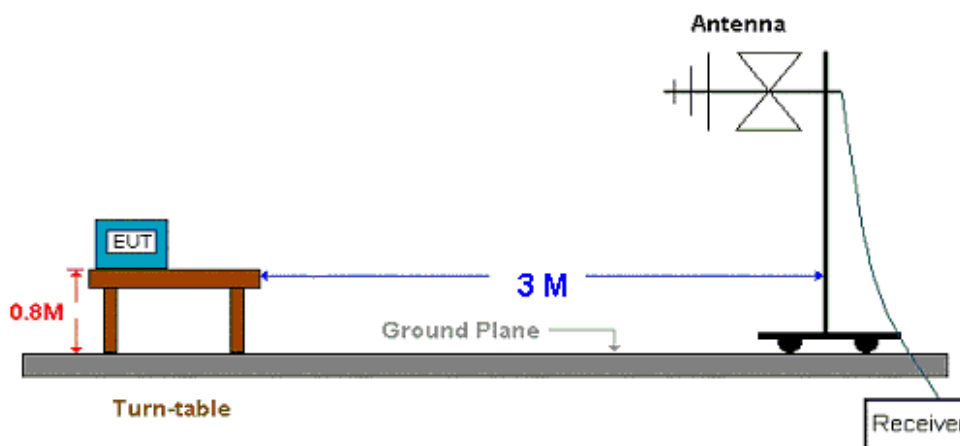

Figure 4.1.2. Generic Test set up at 3-Meter Chamber

Environmental Status

22.5 degree C Temperature, 62% Humidity and 1010mB Barometric Pressure

4.2. Test Facilities - Conducted power line test/Radiated Emissions Test

Description	Supplier	Model/Date of Cal.
EMI Receiver	ROHDE & SCHWARZ	ESHS30 / Mar 2000
LISN	SCHWARZ BECK	NNLK 8121/Mar 2000
LISN	ROHDE & SCHWARZ	ESH3-Z5/Mar 2000
ESXS-K1	ROHDE & SCHWARZ	1082.9678.02 840.913/246
Cables	10Khz~30Mhz	No.10/Jul 2000
Antenna	ROHDE & SCHWARZ	HZ-12 842899/08 30~300Mhz / Jul 2000
Antenna	ROHDE & SCHWARZ	HZ-13 842007/0004 300~1000Mhz / Jul 2000

4.3. Test Procedure - EUT is tested in 3 meter Anechoic Chamber as outlined below

4.3.1. Conductive power line test

4.3.1.1.. The EUT was placed 0.4 meter from the conducting wall of shielding room and 0.8 meters above the ground plane

4.3.1.2. The frequency range from 0.15Mhz to 30Mhz were investigated

4.3.1.3. The LISN used was 50Ohm / 50 uHenry as specified by EN55022

4.3.1.4. All the support peripherals are connect to the other LISN.

4.3.1.5. Cables and peripherals were moved to find the maximum emission levels for each frequency.

4.3.2. Radiated Emission Test

4.3.2.1. The EUT was placed on a table. The top of the table was 0.8 meters above the ground plane and 3 meters from the antenna. The antenna was positioned 1.5 meters up from the ground plane.

4.3.2.2. The frequency range from 30MHz to 1000MHz, the measurement were made at 3 meters, with a Bi-log antenna.

4.4. Test spec

4.4.1. Limit of conducted power line emission class B

<u>Frequency Range</u>	<u>Quasi Peak</u>	<u>Average</u>
0.15~0.5Mhz	66-56 dBuV	56-46 dBuV
0.5~5Mhz	56dBuV	46dBuV
5~30Mhz	60dBuV	50dBuV

4.4.2. Limit of Radiated emission class B

<u>Frequency Range</u>	<u>Measurement Distance</u>	<u>Limit (cBuV/m)</u>
30~230Mhz	10 (M)	30
230~1000Mhz	10 (M)	37

4.5. Test Results

Preliminary Scan result in 3 meter Chamber, see attachments.

4.6. Summary : *PASS*

As can be seen from the results in attached figures, no frequencies were determined to be over the limited.



HomeTek Technology Inc.

13F, No.2, Jian Ba Rd, Jung-He City,
 Taipei, Taiwan, R.O.C.
 Tel: 02-8226-9170
 Fax: 02-8226-9167

Data#: 562 File#: YEONG YANG CO.,LTD.EMI

Date: 2003-08-13 Time: 14:15:09

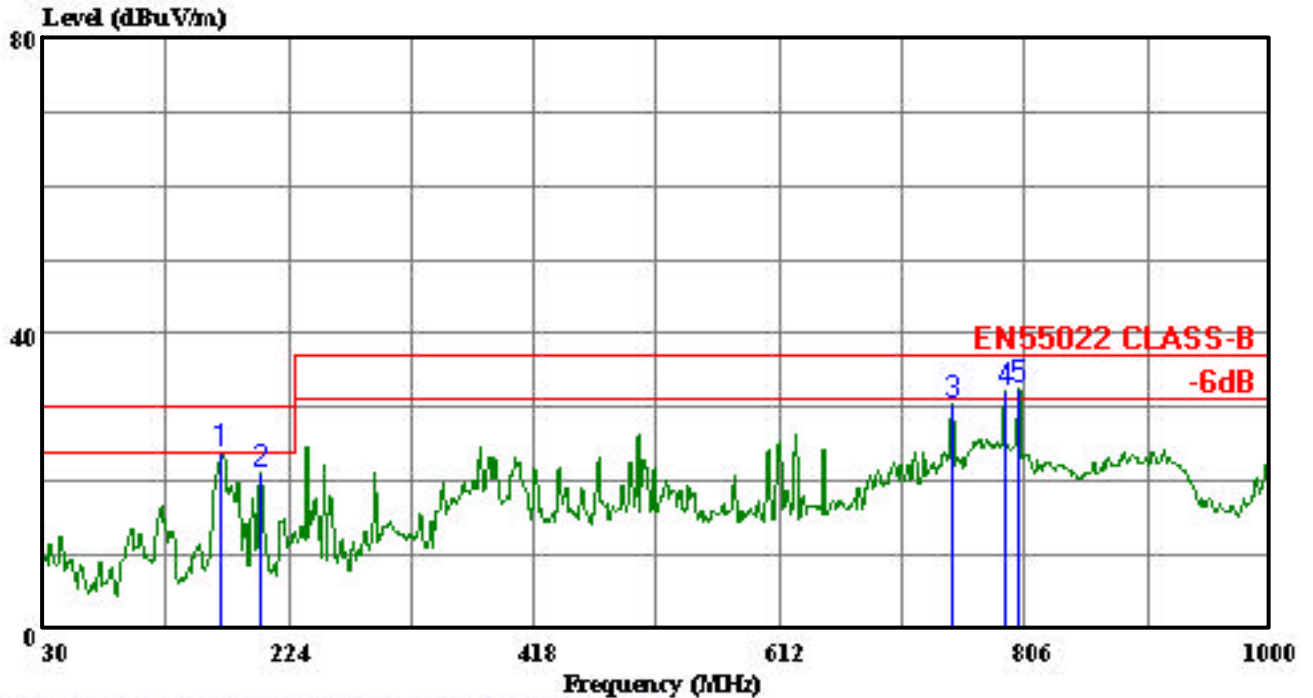

HomeTek Technology Inc. (JUNGHE 7*4*3 CHAMBER)

Trace: 560

Ref Trace:

Condition: EN55022 CLASS-B 10m 20030724 HORIZONTAL

EUT : 55XX

POWER: 230V

MEMO : TEST MODE:PC ONLY

: CPU:INTEL P4 3G

: HDD:SEAGATE 40G

: CD-ROM:ACER 40X

: POWER:EVER POWER HPC 300-202PFC

: RAM:KINGSTON DDR400 512MB *2

: M/B:AOPEN AX4C MAX II

Page:

	Freq	Level	Limit	Over	Read		
	MHz	dBuV/m	dBuV/m	Limit	Level	Factor	Remark
				dB	dBuV	dB	
1	170.650	23.77	30.00	-6.23	39.20	-15.43	
2	202.660	21.09	30.00	-8.91	34.20	-13.11	
3	748.770	30.61	37.00	-6.39	32.80	-2.19	
4 !	790.480	32.16	37.00	-4.84	31.40	0.76	
5 !	800.180	32.66	37.00	-4.34	33.20	-0.54	



13F, No.2, Jian Ba Rd, Jung-He City,
 Taipei, Taiwan, R.O.C.
 Tel: 02-8226-9170
 Fax: 02-8226-9167

HomeTek Technology Inc.

Data#: 563 File#: YEONG YANG CO.,LTD.EMI

Date: 2003-08-13 Time: 14:15:28

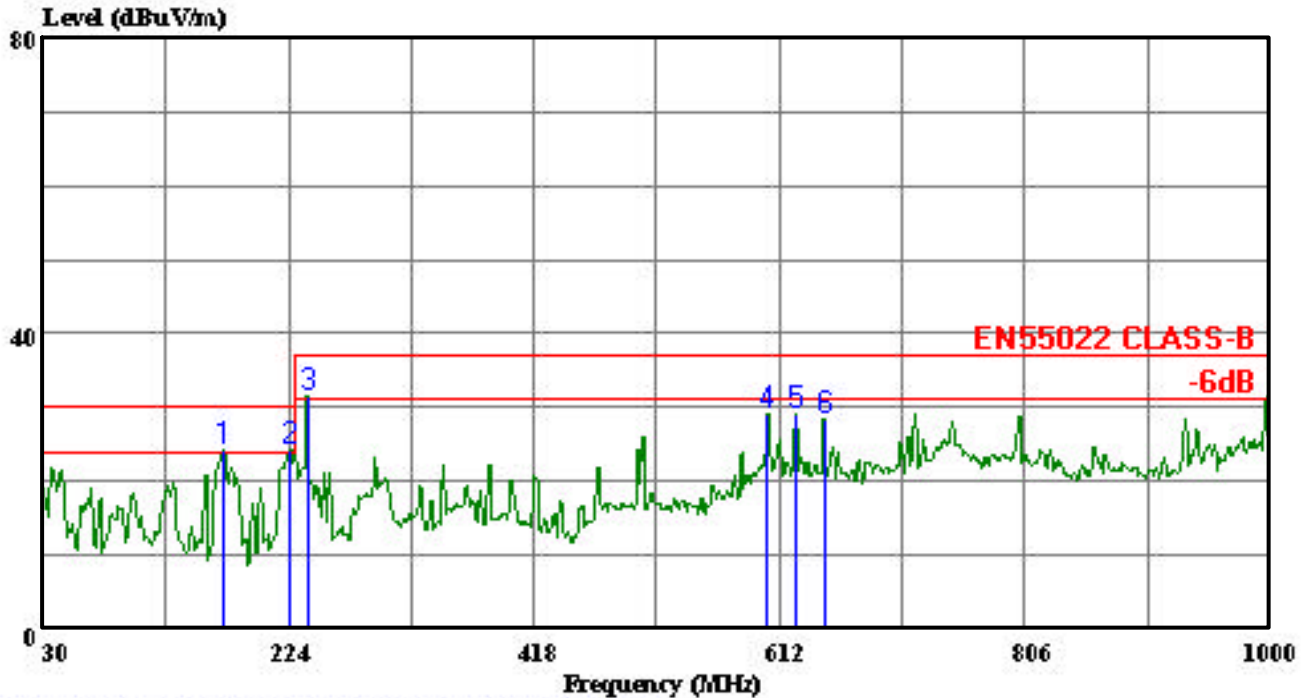

HomeTek Technology Inc. (JUNGHE 7*4*3 CHAMBER)

Trace: 561

Ref Trace:

Condition: EN55022 CLASS-B 10m 20030724 VERTICAL

EUT : 55XX

POWER: 230V

MEMO : TEST MODE:PC ONLY

: CPU:INTEL P4 3G

: HDD:SEAGATE 40G

: CD-ROM:ACER 40X

: POWER:EVER POWER HPC 300-202PFC

: RAM:KINGSTON DDR400 512MB *2

: M/B:AOPEN AX4C MAX II

Page:

	Freq	Level	Limit	Over	Read		Remark
	MHz	dBuV/m	dBuV/m	Limit	Level	Factor	
				dB	dBuV	dB	
1 !	172.590	24.38	30.00	-5.63	37.80	-13.43	
2 !	224.000	24.19	30.00	-5.81	27.80	-3.61	
3 !	238.550	31.52	37.00	-5.48	35.60	-4.08	
4	602.300	28.96	37.00	-8.04	31.40	-2.44	
5	625.580	29.15	37.00	-7.85	32.20	-3.05	
6	647.890	28.28	37.00	-8.72	31.20	-2.92	



13F, No.2, Jian Ba Rd, Jung-He City,
 Taipei, Taiwan, R.O.C.
 Tel: 02-8226-9170
 Fax: 02-8226-9167

HomeTek Technology Inc.

Data#: 566 File#: YEONG YANG CO.,LTD.EMI

Date: 2003-08-13 Time: 14:18:25

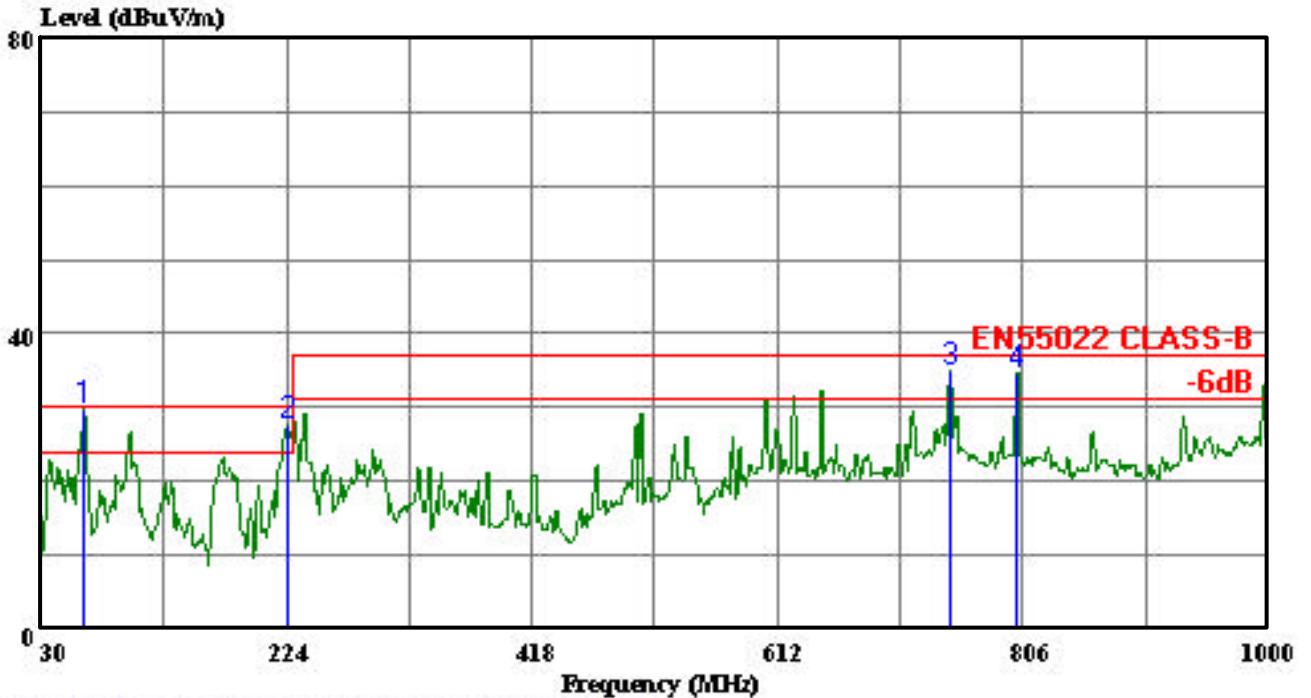

HomeTek Technology Inc. (JUNGHE 7*4*3 CHAMBER)

Trace: 564

Ref Trace:

Condition: EN55022 CLASS-B 10m 20030724 VERTICAL

EUT : 55XX

POWER: 230V

MEMO : TEST MODE:FRONT USB

: CPU:INTEL P4 3G

: HDD:SEAGATE 40G

: CD-ROM:ACER 40X

: POWER:EVER POWER HPC 300-202PFC

: RAM:KINGSTON DDR400 512MB *2

: M/B:AOPEN AX4C MAX II

Page:

	Freq	Level	Limit	Over	Read		
	MHz	dBuV/m	Line	Limit	Level	Factor	Remark
			dBuV/m	dB	dBuV	dB	
1 !	62.980	29.64	30.00	-0.36	42.00	-12.36	
2 !	224.000	27.79	30.00	-2.21	31.40	-3.61	
3 !	748.770	35.15	37.00	-1.85	34.20	0.95	
4 !	800.180	34.66	37.00	-2.34	35.80	-1.14	



13F, No.2, Jian Ba Rd, Jung-He City,
 Taipei, Taiwan, R.O.C.
 Tel: 02-8226-9170
 Fax: 02-8226-9167

HomeTek Technology Inc.

Data#: 567 File#: YEONG YANG CO.,LTD.EMI

Date: 2003-08-13 Time: 14:19:47

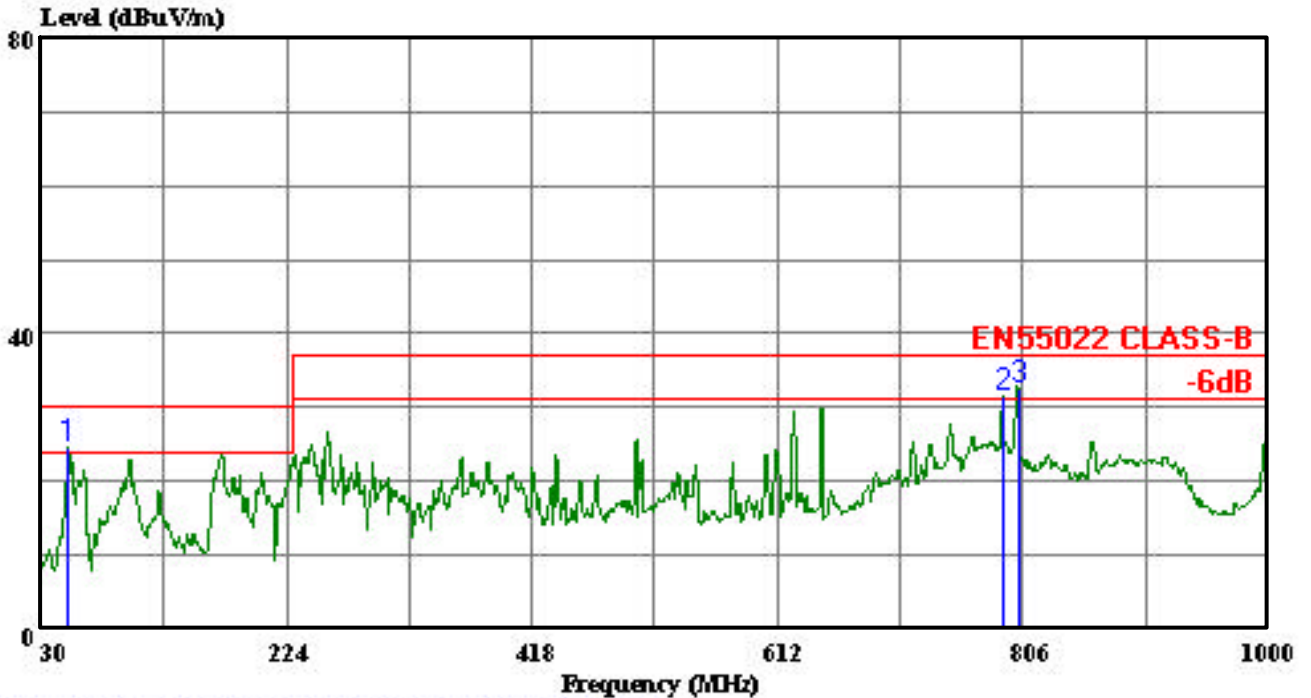

HomeTek Technology Inc. (JUNGHE 7*4*3 CHAMBER)

Trace: 565

Ref Trace:

Condition: EN55022 CLASS-B 10m 20030724 HORIZONTAL

EUT : 55XX

POWER: 230V

MEMO : TEST MODE:FRONT USB

: CPU:INTEL P4 3G

: HDD:SEAGATE 40G

: CD-ROM:ACER 40X

: POWER:EVER POWER HPC 300-202PFC

: RAM:KINGSTON DDR400 512MB *2

: M/B:AOPEN AX4C MAX II

Page:

	Freq	Level	Limit	Over	Read		
	MHz	dBuV/m	dBuV/m	Limit	Level	Factor	Remark
				dB	dBuV	dB	
1 !	50.370	24.51	30.00	-5.49	40.80	-16.29	
2 !	790.480	31.36	37.00	-5.64	30.60	0.76	
3 !	802.120	32.56	37.00	-4.44	33.60	-1.04	



HomeTek Technology Inc.

13F, No.2, Jian Ba Rd, Jung-He City,
 Taipei, Taiwan, R.O.C.
 Tel: 02-8226-9170
 Fax: 02-8226-9167

Data#: 577 File#: YEONG YANG CO.,LTD.EMI

Date: 2003-08-13 Time: 14:37:20

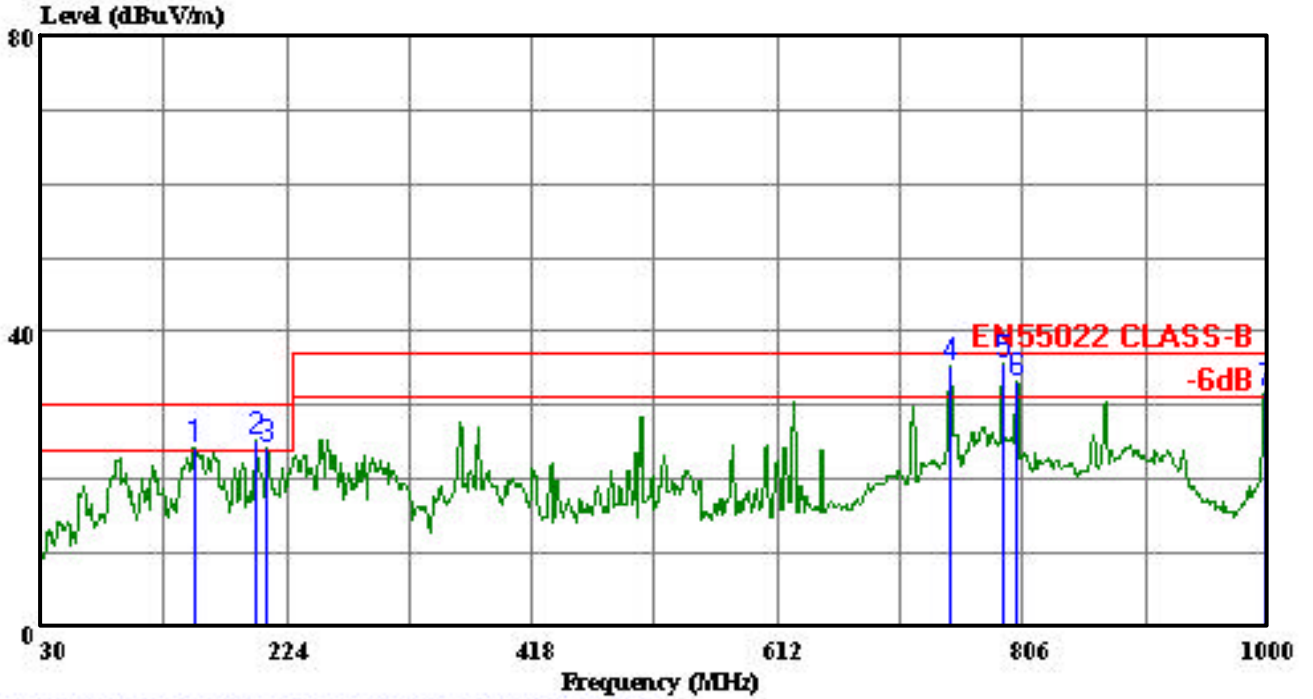

HomeTek Technology Inc. (JUNGHE 7*4*3 CHAMBER)

Trace: 575

Ref Trace:

Condition: EN55022 CLASS-B 10m 20030724 HORIZONTAL

EUT : 55XX

POWER: 230V

MEMO : TEST MODE:FULL SYSTEM

: CPU:INTEL P4 3G

: HDD:SEAGATE 40G

: CD-ROM:ACER 40X

: POWER:EVER POWER HPC 300-202PFC

: RAM:KINGSTON DDR400 512MB *2

: M/B:AOPEN AX4C MAX II

Page:

	Freq	Level	Limit	Over	Read	Factor	Remark
	MHz	dBuV/m	dBuV/m	Limit	Level	dB	
1 !	151.250	24.38	30.00	-5.62	41.80	-17.42	
2 !	200.720	25.36	30.00	-4.64	39.00	-13.64	
3 !	208.480	24.35	30.00	-5.65	41.40	-17.05	
4 !	748.770	35.21	37.00	-1.79	37.40	-2.19	
5 !	790.480	35.76	37.00	-1.24	35.00	0.76	
6 !	800.180	33.26	37.00	-3.74	33.80	-0.54	
7 !	997.090	31.84	37.00	-5.16	36.40	-4.56	



HomeTek Technology Inc.

13F, No.2, Jian Ba Rd, Jung-He City,
 Taipei, Taiwan, R.O.C.
 Tel: 02-8226-9170
 Fax: 02-8226-9167

Data#: 578 File#: YEONG YANG CO.,LTD.EMI

Date: 2003-08-13 Time: 14:38:36

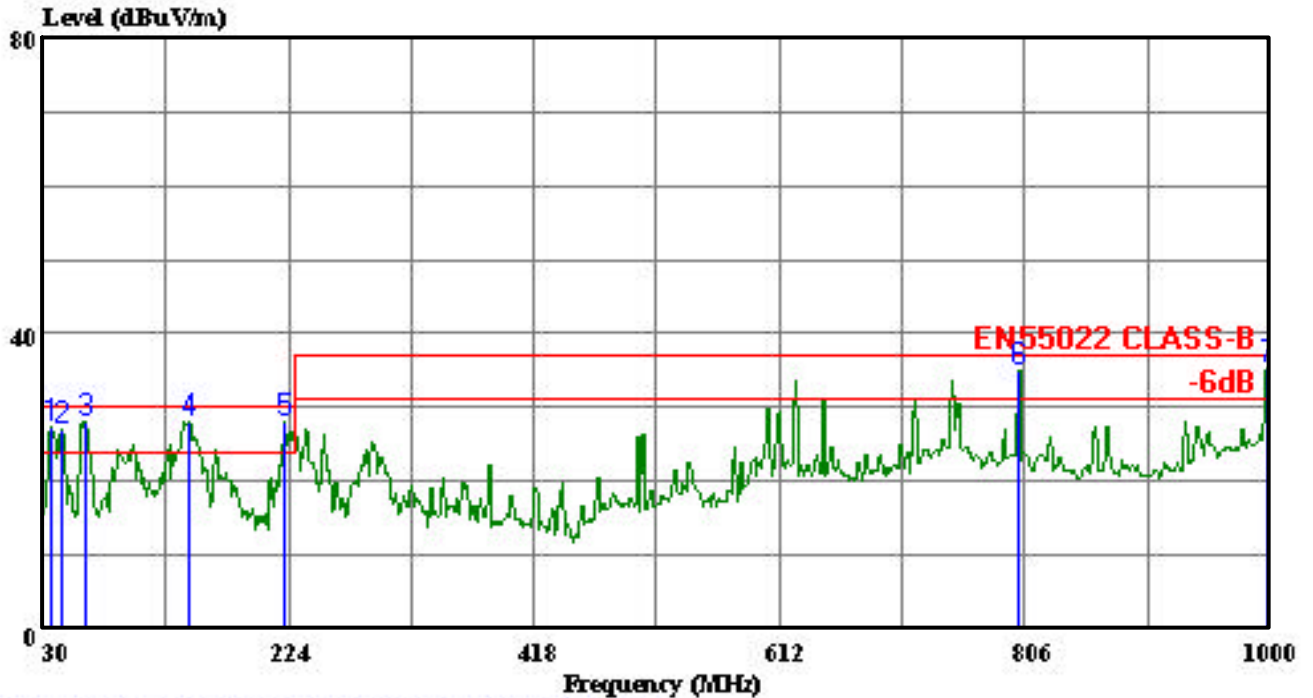

HomeTek Technology Inc. (JUNGHE 7*4*3 CHAMBER)

Trace: 576

Ref Trace:

Condition: EN55022 CLASS-B 10m 20030724 VERTICAL

EUT : 55XX

POWER: 230V

MEMO : TEST MODE:FULL SYSTEM

: CPU:INTEL P4 3G

: HDD:SEAGATE 40G

: CD-ROM:ACER 40X

: POWER:EVER POWER HPC 300-202PFC

: RAM:KINGSTON DDR400 512MB *2

: M/B:AOPEN AX4C MAX II

Page:

	Freq	Level	Limit	Over	Read		Remark
	MHz	dBuV/m	dBuV/m	dB	dBuV	dB	
1 !	36.790	27.52	30.00	-2.48	36.60	-9.08	
2 !	45.520	27.08	30.00	-2.92	33.60	-6.52	
3 !	62.980	28.04	30.00	-1.96	40.40	-12.36	
4 !	144.460	27.97	30.00	-2.03	41.80	-13.83	
5 !	221.090	28.04	30.00	-1.96	33.60	-5.56	
6 !	800.180	34.86	37.00	-2.14	36.00	-1.14	
7 !	997.090	35.23	37.00	-1.77	34.20	1.03	